

N. A. E. Library

NATIONAL AERONAUTICAL ESTABLISHMENT  
LIBRARY

R. & M. No. 2686  
(9,017, 10,501)  
A.R.C. Technical Report



RECEIVED  
NATIONAL AERONAUTICAL  
ESTABLISHMENT  
16 APR 1952  
MR. GERRARD, ENCL.

MINISTRY OF SUPPLY

AERONAUTICAL RESEARCH COUNCIL  
REPORTS AND MEMORANDA

# Sandwich Construction and Core Materials. Part V.

## SECTION I

Some Physical Properties of an Extruded Cellular Cellulose Acetate

## SECTION II

The Determination of Poisson's Ratio in Compression of Certain  
Low Density Materials

*By*

W. J. PULLEN,  
of the Engineering Division, N.P.L.

*Crown Copyright Reserved*

LONDON: HIS MAJESTY'S STATIONERY OFFICE

1952

FOUR SHILLINGS NET

RECEIVED  
NATIONAL AERONAUTICAL  
ESTABLISHMENT  
16 APR 1952  
MR. GERRARD, ENCL.

# Sandwich Construction and Core Materials. Part V

(In Two Sections)

By

W. J. PULLEN,

of the Engineering Division, N.P.L.

## SECTION I

### Some Physical Properties of an Extruded Cellular Cellulose Acetate

*Reports and Memoranda No. 2686*

*April, 1947*

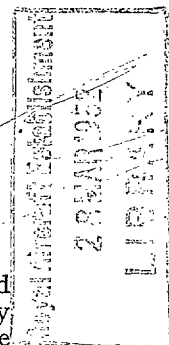

*Summary.*—Tensile, Compressive and Creep tests have been carried out on four different samples of Extruded Cellular Cellulose Acetate. It is concluded that the material is comparable with calcium alginate and other low-density materials so far handled in the Engineering Division, N.P.L. In particular, the samples are not subject to the same degree of 'softening' as has been the case with some similar materials. The 'filled' samples are more efficient than the 'unfilled' ones and are worth considering as possible low-density stabilizers in sandwich construction.

*Introduction.*—A study has been made of four commercially prepared samples of Extruded Cellular Cellulose Acetate. Two of the samples were stated to be 'unfilled' foams, while the remaining two were stated to contain glass fibres. The samples were not large enough to permit a comprehensive investigation to be carried out. It was, however, possible to evaluate:—

1. The apparent modulus in compression and the ultimate strength in compression.
2. The ultimate tensile strength in two directions, the transverse tensile strength and the tensile strength in the 0 deg or longitudinal direction, as indicated in Fig. 1.
3. The behaviour of each sample when subjected to a constant bending stress at two fixed temperatures, namely 25 deg C and 71 deg C, see Fig. 3.

Table 1 gives details of each sample as received.

TABLE 1

N.P.L. Eng. Division Test Mark	Manufacturer's Reference	Density lb/ft <sup>3</sup>	Remarks
QJW. 1	JM. 6730—6½	7.2	Filled
QJW. 2	JM. 6730—8	6.2	Filled
QJW. 3	JR. 6654	4.8	Unfilled
QJW. 4	JR. 6654—4 ft <sup>3</sup>	3.8	Unfilled

*Description of Tests and Results of Tests.*—*Measurement of Apparent Modulus in Compression.*—Cylindrical test-pieces approximately 1⅜ in. diameter and ½ in. thick were machined from the boards. The skin was removed by grinding and the faces of the finished test-pieces were parallel to within ± 0.0005 in. The tests were carried out in a special rig which enabled load

to be applied to a test-piece through flap parallel platens. A load of 10 lb was applied throughout the test and an additional load of 41 lb was repeatedly applied and removed by an arrangement of cam and levers. The relative movement of the two platens was measured by a mirror-type extensometer sensitive to  $10^{-5}$  in. The additional load was repeatedly applied until the corresponding strain measurements became constant. The time interval between successive readings was 30 seconds.

*Determination of the Crushing Strength in Compression.*—The test-pieces which had previously been used in the determination of the apparent modulus in compression were tested between flat parallel platens in a single-lever testing machine of 500 lb capacity. The crushing load was obtained by noting the maximum load which the test-piece would withstand without marked yielding. The results of the compression tests are given in Table 2.

TABLE 2

N.P.L. Eng. Division Test Mark	Density gm/cc	Apparent Modulus in compression lb/sq in.	Specific Modulus Km	Crushing Strength lb/sq in.	Specific crushing strength Km
QJW. 1C	0.114	14590	92.1	223	1.37
QJW. 1D	0.118	12660	75.4	227	1.35
QJW. 2C	0.108	12750	83.0	212	1.38
QJW. 2D	0.111	9424	59.7	204	1.29
QJW. 3C	0.075	5655	53.0	68	0.64
QJW. 3D	0.076	6187	57.2	74	0.63 <sub>5</sub>
QJW. 4C	0.062	2633	29.9	57	0.65
QJW. 4D	0.062	1911	21.7	59	0.67

*Determination of the Ultimate Strength in Tension.*—(a) *In the 0 deg Direction.*—Rectangular pieces approximately  $4\frac{1}{2} \times 2 \times \frac{1}{2}$  in. thick were machined from the boards. These were reinforced to a depth of approximately 1 in. by glueing on pieces of  $\frac{1}{8}$  in. thick birch plywood. The reinforced test-pieces were then machined to a form similar to the dumb-bell type tensile test-pieces referred to in BS 771 and LP-40-6a—Fig. 3 excepting that they were thicker and were only waisted in one direction. Each test-piece was assembled in the special grips shown in Fig. 2. The grips were then located by means of a system of links in a 500-lb capacity single-lever testing machine and load was applied at a constant rate.

(b) *In the Transverse Direction.*—The tensile strength in the transverse direction of each board was measured by glueing cylindrical test-pieces approximately  $1\frac{3}{8}$  in. diameter and  $\frac{1}{2}$  in. thick to steel end fittings as shown in Fig. 1. These test-pieces were loaded axially at a constant rate in a hand-operated testing machine of 500 lb capacity. The results of the tensile tests are given in Tables 3 and 4.

TABLE 3

*Results of Tensile Tests in the 0 deg Direction*

N.P.L. Eng. Division Test Mark	Density gm/cc	Tensile Strength lb/sq in.	Specific Tensile Strength Km
QJW. 1E	0.114	190.0	1.17
QJW. 2E	0.104	113.0	0.76
QJW. 3E	0.078	70.0	0.63
QJW. 4E	0.061	69.0	0.79

TABLE 4

*Results of Transverse Tensile Tests*

N.P.L. Eng. Division Test Mark	Density gm/cc	Tensile Strength lb/sq in.	Specific Tensile Strength Km
QJW. 1A	0.114	300	1.85
QJW. 1B	0.114	333	2.06
QJW. 2A	0.104	280	1.89
QJW. 2B	0.104	328	2.21
QJW. 3A	0.081	98	0.85
QJW. 3B	0.075	83.5	0.78
QJW. 4A	0.061	63	0.73
QJW. 4B	0.061	71.5	0.82

'Softening' Tests.—Test-pieces approximately  $3 \times 0.9 \times 0.4$  in. were cut from each board. Each test-piece was tested first at 25 deg C allowed to recover to the minimum possible deformation in a reasonable time\*, then tested at 71 deg C again being allowed to recover on removal of load. The test procedure was as follows:—the test-piece was placed in a thermostatically-controlled oven in a test rig of the type shown in Fig. 3. A thermocouple embedded in the test-piece enabled the temperature to be recorded throughout the test. During each test the temperature varied by less than  $\pm 1$  deg C. As soon as the thermocouple reading was constant, load was applied to the test-piece by releasing a weight by means of a thread passing through the roof of the oven.

Angular deflection of the test-piece was measured by viewing through a telescope the reflection in a mirror attached to the test-piece holder of an illuminated scale placed at a distance of 90 inches therefrom. Readings were taken at intervals of time and converted into percentage nominal skin strain and plotted as shown in Figs. 4 and 5. After each test during recovery, readings were taken and plotted as also shown in Figs. 4 and 5. The duration of each test was such, that the strain did not reach such a value, as to cause serious departure from constant bending-moment in the test-piece. The curves in Figs. 5 and 6 show a plot of total deformation against time. The left-hand ordinate, percentage nominal skin strain refers to the deformation under load and the right-hand ordinate refers to the recovery occurring during a period following removal of load. The recovery curves are plotted so as to facilitate comparison with the behaviour of the material under load. That is the values for residual strain are plotted downwards from a zero at the top of the diagram. Thus complete recovery would be represented by a line passing through this zero. The curves may also be used to estimate changes in Young's Modulus of the material, in as much as they are approximately horizontal when the first reading is taken, that is after 10 seconds. Extrapolation to zero slope gives an indication of the instantaneous deflection under the given load from which Young's Modulus can be evaluated.

*Conclusions.*—It is concluded that of the four samples tested, the two filled foams are comparable with Calcium Alginate foams and compare favourably with other low-density materials tested. The softening tests reveal that the filled samples withstand a temperature of 71 deg C without serious softening and that, whilst recoverable creep predominates at 25 deg C, irrecoverable creep is a considerable factor at 71 deg C. The curves in Figs. 4 and 5 indicate that, with the filled materials, a reduction in Young's Modulus of 20 to 25 per cent may be expected on the temperature being raised from 25 deg C to 71 deg C. In the case of the unfilled materials the reduction varies from 30 to 40 per cent.

\* At 25 deg C recovery was virtually complete within 48 hours in all cases.

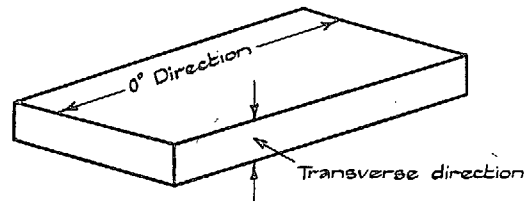

(a) Sketch showing directions in which test pieces were cut

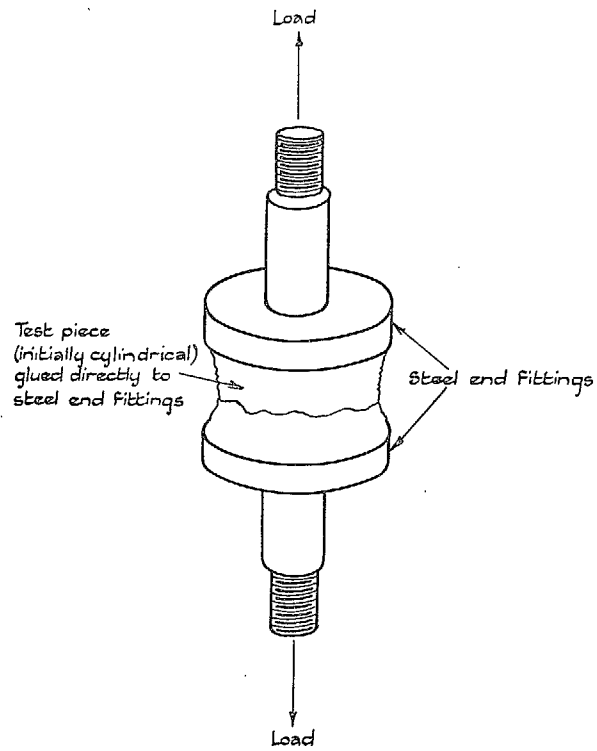

(b) Cross-grain tensile test piece

FIG. 1.

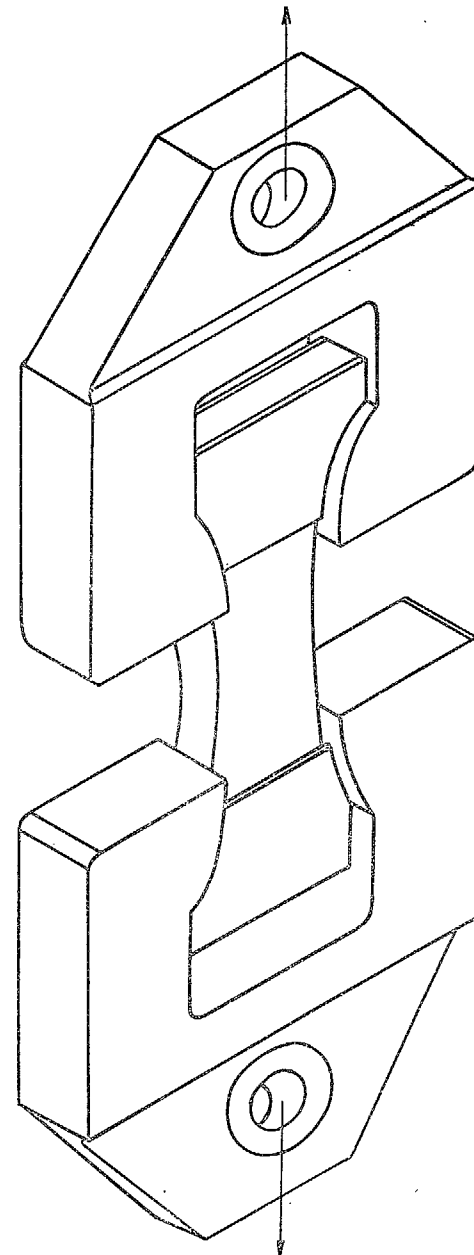

FIG. 2. Dumb-bell type grips used for the 0 deg direction tensile tests.

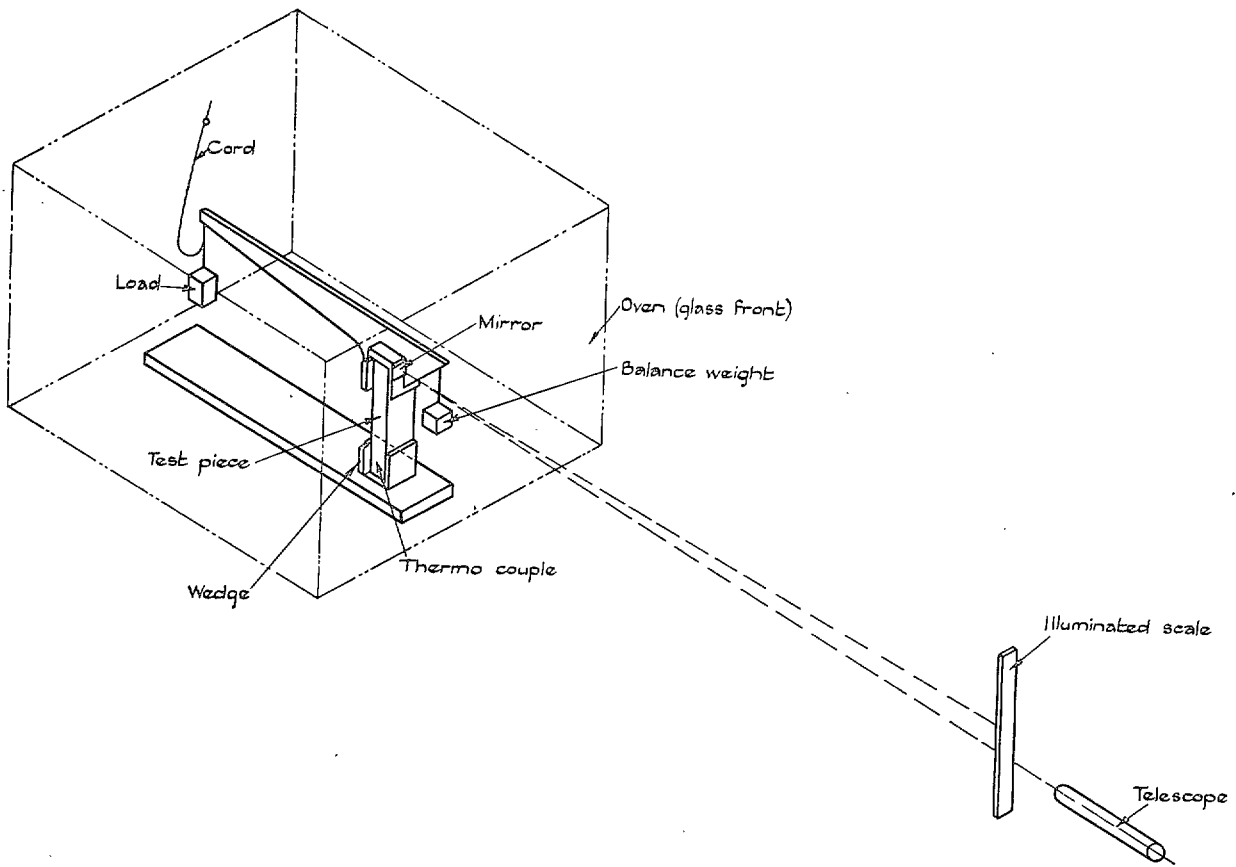

FIG. 3. Arrangement of softening test.

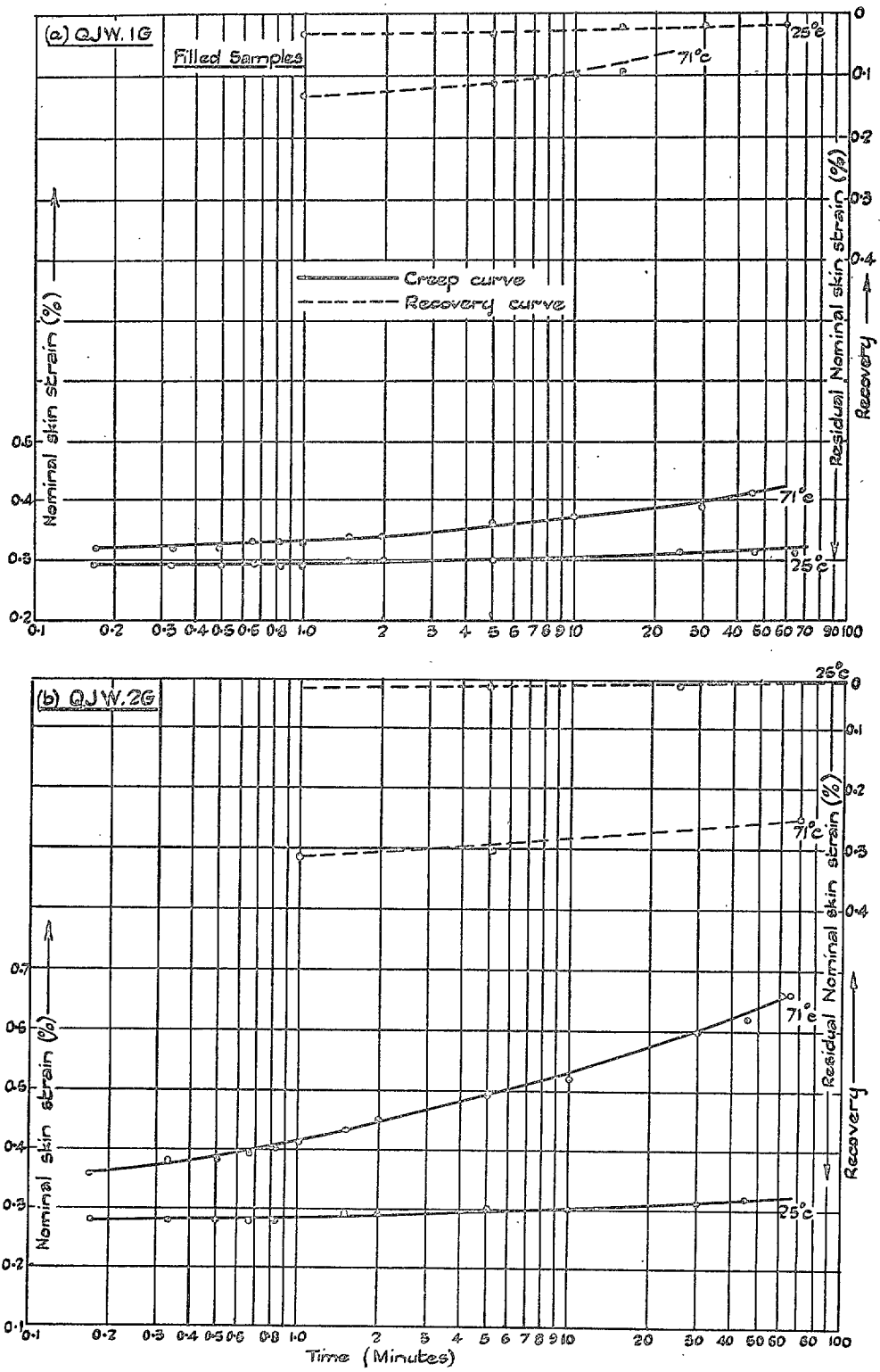
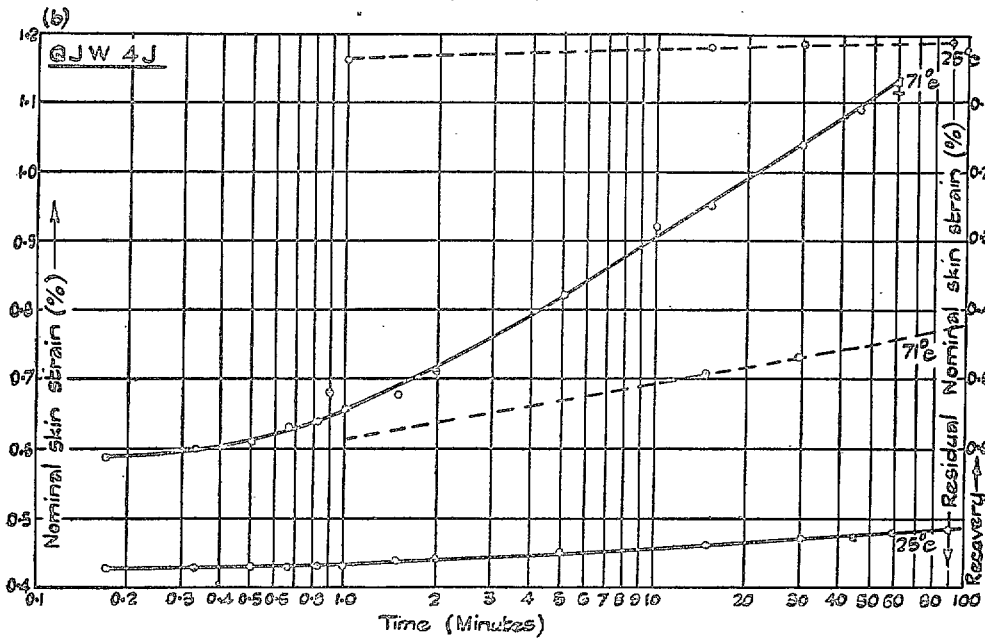
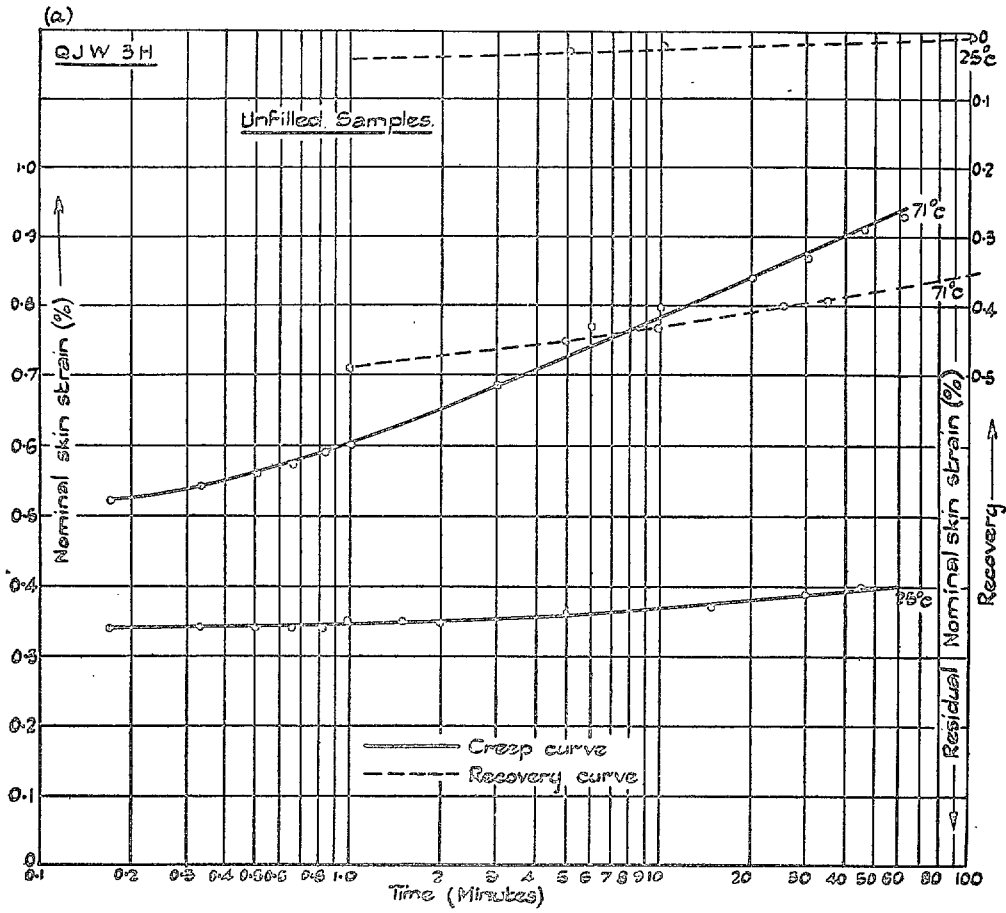

FIG. 4.



E.E.M.

FIG. 5.



SECTION II  
The Determination of Poisson's Ratio in Compression of  
Certain Low Density Materials

*Summary.*—Four low-density materials, each representative of a different class, have been tested. Whilst the results given in this report are not exhaustive they give an indication of the order of Poisson's ratio for materials of the low density type.

*Introduction.*—As part of the research programme on sandwich structures in the Engineering Division, N.P.L., it became necessary to measure the Poisson's ratio for certain low density elastic stabilizers. The low density materials selected were as follows :—

1. Balsa wood—a natural product.
2. Calcium Alginate—a foamed material.
3. Expanded Polyvinyl Formal (Formvar).
4. A low-density Urea Formaldehyde gel.

The tests were carried out in compression. Fig. 1 shows the directions, relative to the main samples, in which the test-pieces were cut and tested.

*Method of Test.*—Test-pieces approximately  $0.8 \times 0.5 \times 1.5$  in. long were cut from each sample of low density material. Each test-piece was set up in a special apparatus described elsewhere<sup>1</sup>. The longitudinal compressive strain was measured by the special Marten's Extensometer fitted to this apparatus. At the same time the lateral strain in the direction indicated in Fig. 1 was measured by means of a Lamb Lateral Extensometer. Small surface plates were used between the test-piece and the bearing surfaces of the Extensometer to minimise local compression and a special light spring was used in the Extensometer. The weight of the Extensometer was supported so as to avoid any local bending effect on the test-piece. A constant load was applied to the test-piece in compression and an additional load was applied and removed at regular intervals of time. Both longitudinal and lateral deflections were recorded and the test continued until the deflections occurring with each cycle of loading and unloading assumed a constant value. Results of the tests are given in Table 1.

TABLE 1  
*Results of Poisson's Ratio Tests in Compression*

Material	N.P.L. Eng. Division Test Mark	Average Density gm/cc	Stress Range lb/sq in.		Direction in which Poisson's Ratio applies	Poisson's Ratio $\sigma$
			Min.	Max.		
Expanded Formvar	QEL. 2	0.126*	35	65	LN	0.006
Calcium Alginate	PVS. 17	0.090	35	65	LN	0.138
Urea Formaldehyde gel.	RBQ. IH	0.108	35	65	LN	0.162
Balsa Wood (1)	OYO. 3	0.073	35	65	LT	0.152
Balsa Wood (2) †	OYO. 3					

\* Density measured on machined sample, *i.e.*, the weight of the skin which normally covers this material was not included in the determination of the density.

† Check test on a second test-piece.

LN Longitudinal-Normal direction, *see* Fig. 1, *i.e.*, Compression longitudinally and lateral extension measured normally.

LT Longitudinal-Tangential direction, *see* Fig. 1, *i.e.*, Compression longitudinally and lateral extension measured tangentially.

*Microscopic Examination of Structure.*—In order to examine whether any obvious correlation existed between cavity shape and the value of Poisson's ratio, a series of sections of the various materials was prepared by slicing. These sections were examined by transmitted light in the Metallurgy Division, N.P.L. Photomicrographs Figs. 2 to 5 and 6 to 9 were prepared at magnifications of X10 and X50 respectively. The sections were cut in two directions, longitudinal and normal, from the actual test-pieces used after they had been tested. Figs. 2 and 6 show the characteristic structure of balsa wood, based on longitudinal fibres joined laterally by plate-like membranes at frequent intervals. The photomicrographs indicate that the conception of balsa as consisting of a series of longitudinal tubes similar to 'Balsolite' (2) may be misleading and that a better structural analogy would be to regard the material as consisting of a large number of slender struts braced together at frequent intervals.

It is interesting to compare the structure of Calcium Alginate Foam with that of Expanded Formvar as shown in Figs. 3 and 7 and Figs. 4 and 8. The former material is made by removing water from a jelly-like structure formed by setting a liquid foam. The latter by releasing gas which has been previously dissolved in the polymer under pressure. The former process is characterised by marked shrinkage after the cavities have been formed and might be expected therefore to produce considerable distortion in their shape. In the latter case there is no subsequent shrinkage and the cavities might be expected to retain their original spherical shape. It was therefore expected that the structure of the two materials would differ considerably, but examination of the microphotographs shows that the detail structure of the two materials is essentially the same. The size of the cavities in the Alginate appears to be more uniform than in the expanded Formvar, which appears to consist of a mixture of very large and very small bubbles.

Figs. 5 and 9 show the extremely fine pore structure of a material of the 'Aerogel' type. The degree of magnification is however insufficient to enable any conclusions on cavity shape to be drawn.

*Conclusions.*—It has been found to be impossible to correlate the measured values of Poisson's ratio with the evidence of structure provided by the photomicrographs. For example, the photomicrographs indicate an essential similarity between Calcium Alginate Foam and expanded Formvar, but the measured values of Poisson's ratio differ completely (0.006 and 0.138). It is estimated by Barwell 1946 (1) that an ideal egg-box structure made of material having a Poisson's ratio of  $\sigma$  would have an apparent Poisson's ratio  $\sigma_1$  where  $\sigma_1 = \sigma / (2 + \sigma)$ . Assuming therefore a perfect egg-box structure, the values of Poisson's ratio of the parent materials calculated from the measured values are 0.012 for Formvar, 0.32 for Calcium Alginate and 0.4 for Urea Formaldehyde. From this it may therefore be concluded that Calcium Alginate solid foam and Urea Formaldehyde gel behave approximately as if egg-box structures, but that the result obtained for expanded Formvar is anomalously low.

## REFERENCES

- | <i>No.</i> | <i>Author</i> | <i>Title, etc.</i>   |
|------------|---------------|--|
| 1.         | F. T. Barwell | Sandwich Construction and Core Materials. Part IV. R. & M. 2467, May, 1946.                              |
| 2.         | W. J. Pullen  | 'Balsolite' Impregnated Paper Cellular Material as an Elastic Stabilizer. A.R.C. 7267 (To be published). |

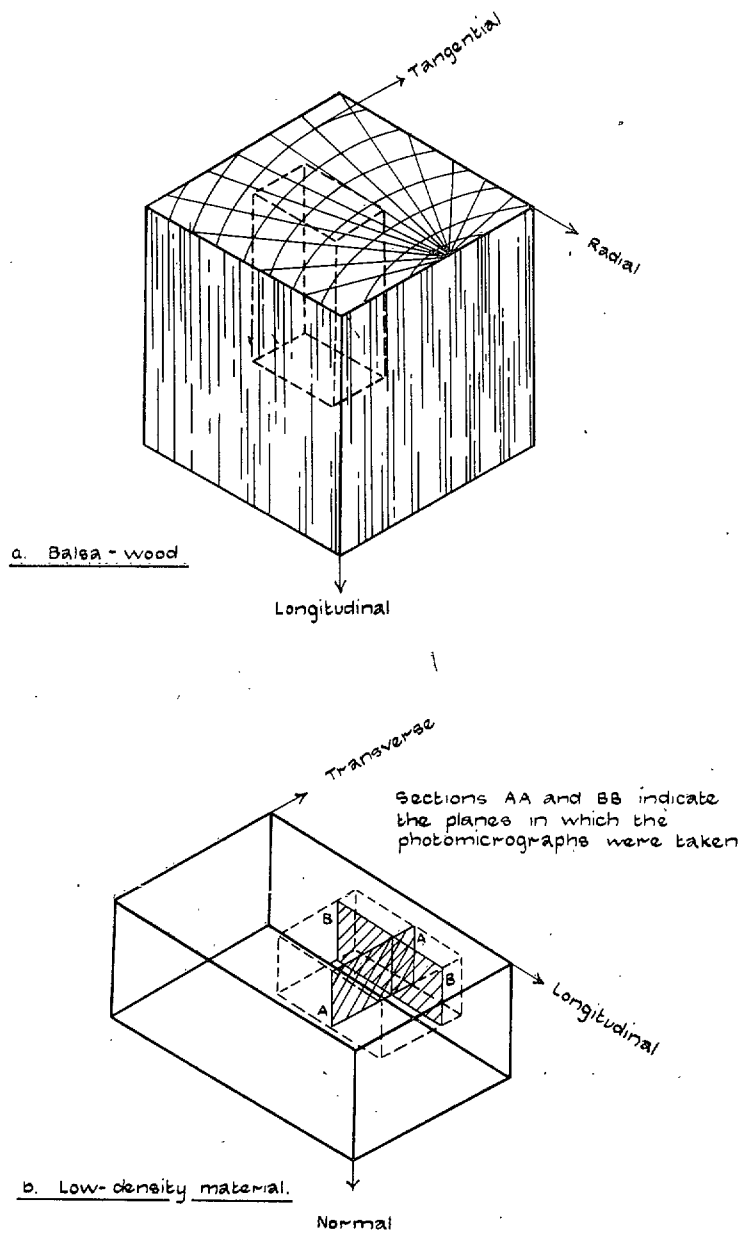

FIG. 1. Sketch showing directions in which test-pieces were cut.

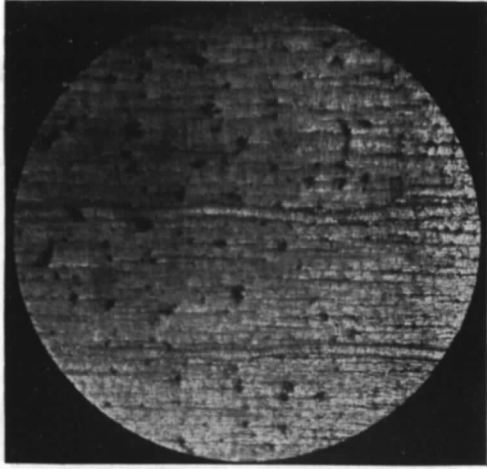

FIG. 2a. No. 2 Balsa. Longitudinal Section.

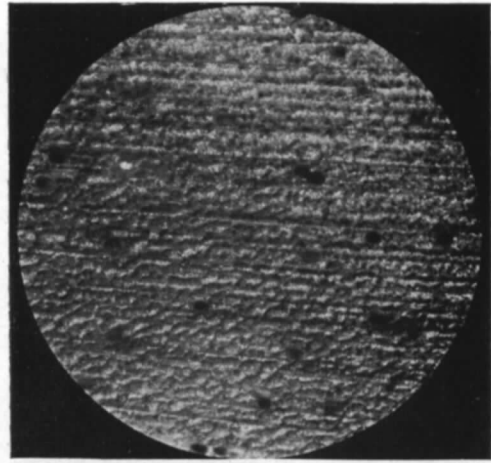

FIG. 2b. No. 1 Balsa. Transverse section.

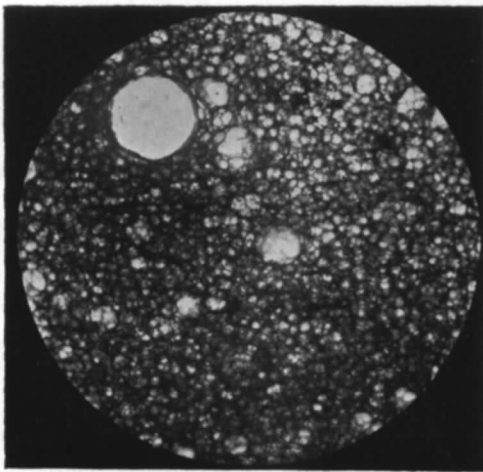

FIG. 3a. No. 3 Alginate. Longitudinal Section.

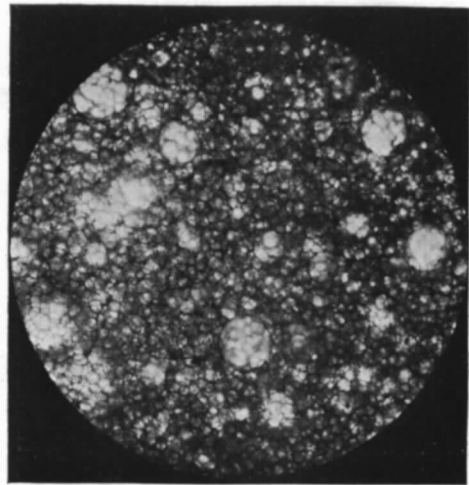

FIG. 3b. No. 4 Alginate. Transverse section.



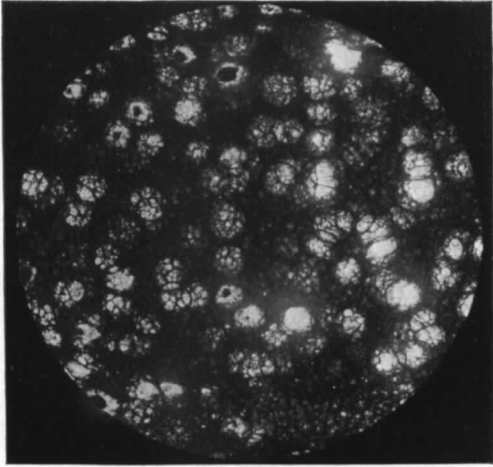

FIG. 4a. No. 5 Formvar. Longitudinal section.  
←

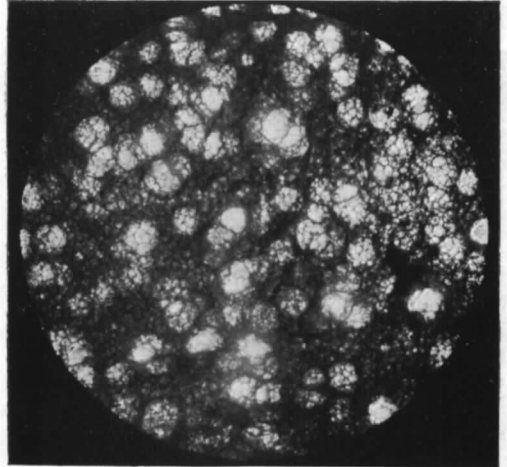

FIG. 4b. No. 6 Formvar. Transverse section.  
←→

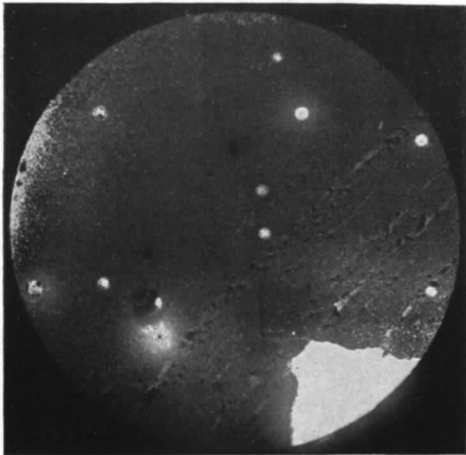

FIG. 5a. No. 7 U.F. Gel. Longitudinal section.  
←

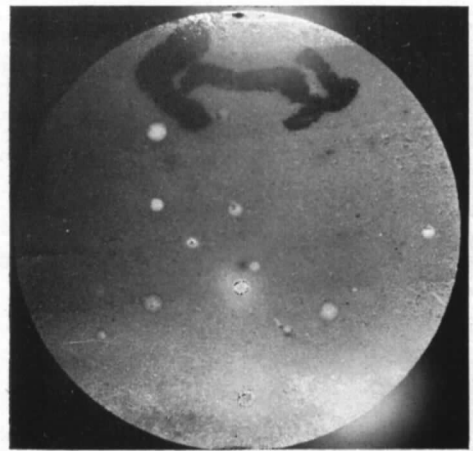

FIG. 5b. No. 8 U.F. Gel. Transverse section.  
←→

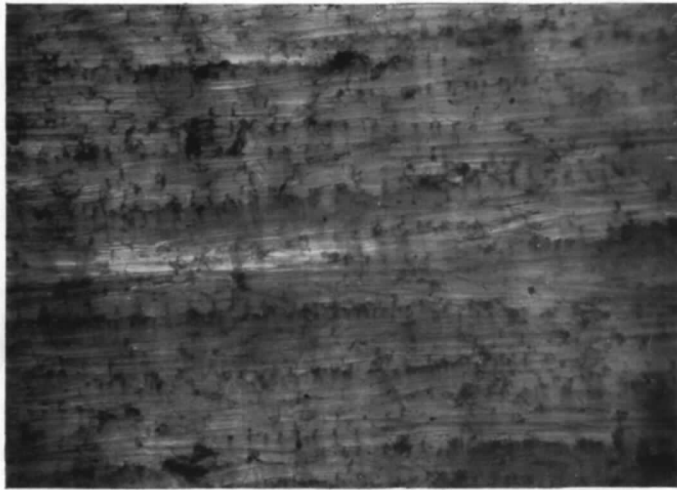

FIG. 6a. No. 2 Balsa. Longitudinal section.

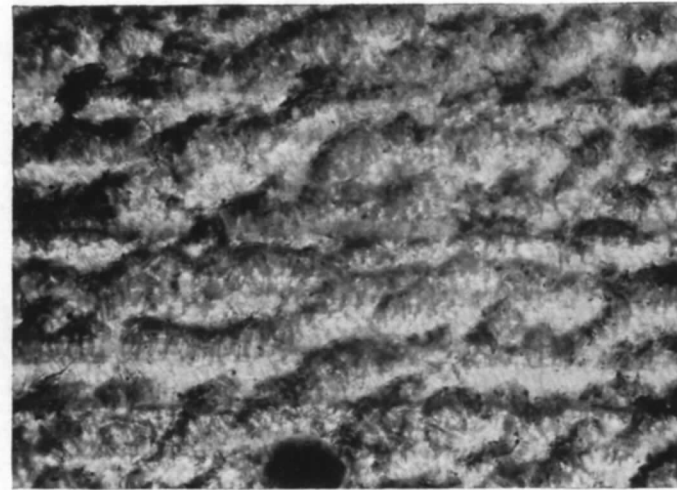

FIG. 6b. No. 1 Balsa. Transverse section.

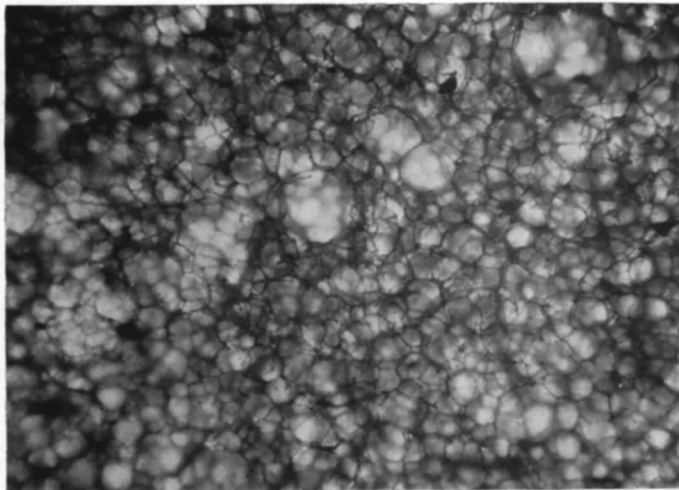

FIG. 7a. No. 3 Alginate. Longitudinal section.

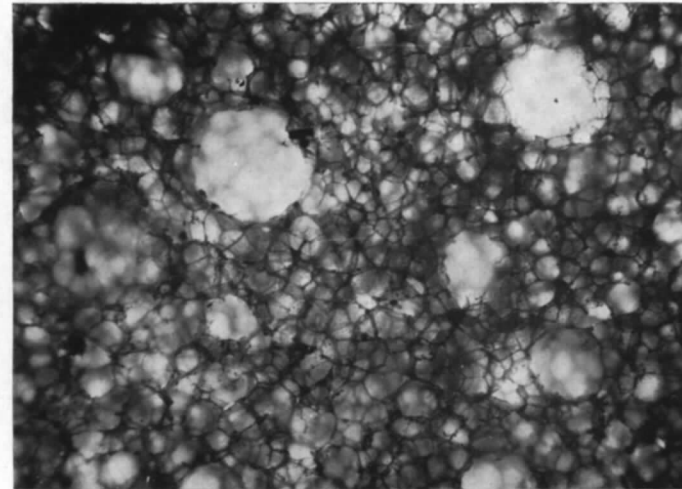
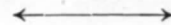

FIG. 7b. No. 4 Alginate. Transverse section.



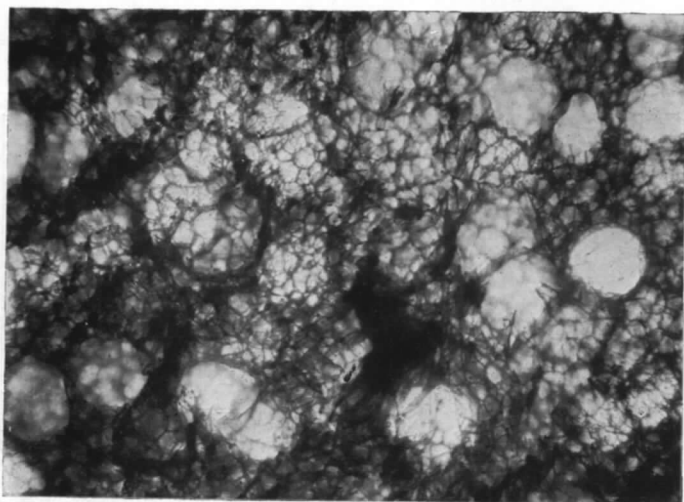

FIG. 8a. No. 5 Formvar. Longitudinal section.

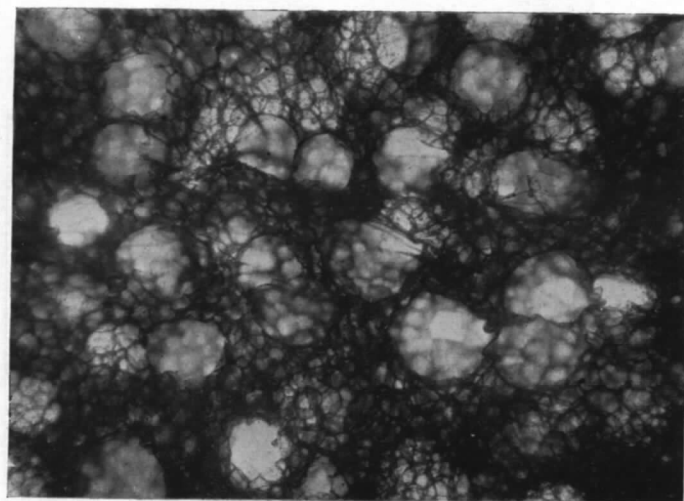

FIG. 8b. No. 6 Formvar. Transverse section.

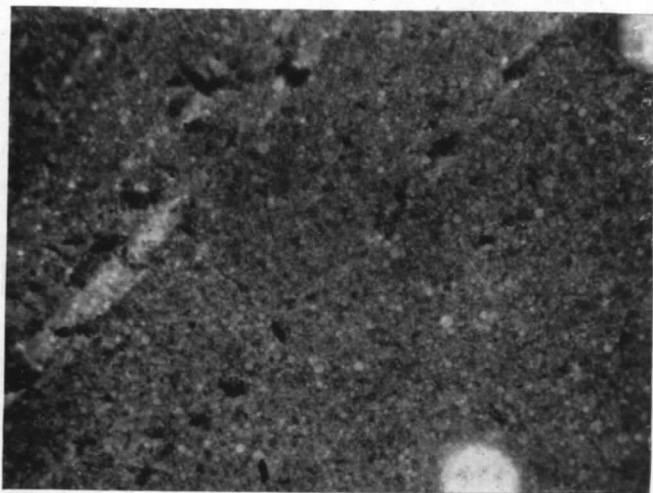

FIG. 9a. No. 7 U.F. Gel. Longitudinal section.

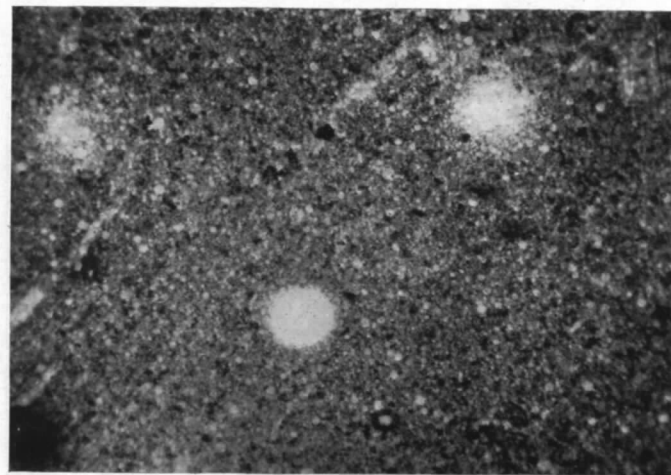

FIG. 9b. No. 8 U.F. Gel. Transverse section





## Publications of the Aeronautical Research Council

### ANNUAL TECHNICAL REPORTS OF THE AERONAUTICAL RESEARCH COUNCIL (BOUND VOLUMES)—

- 1934-35 Vol. I. Aerodynamics. *Out of print.*  
Vol. II. Seaplanes, Structures, Engines, Materials, etc. 40s. (40s. 8d.)
- 1935-36 Vol. I. Aerodynamics. 30s. (30s. 7d.)  
Vol. II. Structures, Flutter, Engines, Seaplanes, etc. 30s. (30s. 7d.)
- 1936 Vol. I. Aerodynamics General, Performance, Airscrews, Flutter and Spinning. 40s. (40s. 9d.)  
Vol. II. Stability and Control, Structures, Seaplanes, Engines, etc. 50s. (50s. 10d.)
- 1937 Vol. I. Aerodynamics General, Performance, Airscrews, Flutter and Spinning. 40s. (40s. 10d.)  
Vol. II. Stability and Control, Structures, Seaplanes, Engines, etc. 60s. (61s.)
- 1938 Vol. I. Aerodynamics General, Performance, Airscrews. 50s. (51s.)  
Vol. II. Stability and Control, Flutter, Structures, Seaplanes, Wind Tunnels, Materials. 30s. (30s. 9d.)
- 1939 Vol. I. Aerodynamics General, Performance, Airscrews, Engines. 50s. (50s. 11d.)  
Vol. II. Stability and Control, Flutter and Vibration, Instruments, Structures, Seaplanes, etc. 63s. (64s. 2d.)
- 1940 Aero and Hydrodynamics, Aerofoils, Airscrews, Engines, Flutter, Icing, Stability and Control, Structures, and a miscellaneous section. 50s. (51s.)

*Certain other reports proper to the 1940 volume will subsequently be included in a separate volume.*

### ANNUAL REPORTS OF THE AERONAUTICAL RESEARCH COUNCIL—

1933-34	1s. 6d. (1s. 8d.)
1934-35	1s. 6d. (1s. 8d.)
April 1, 1935 to December 31, 1936	4s. (4s. 4d.)
1937	2s. (2s. 2d.)
1938	1s. 6d. (1s. 8d.)
1939-48	3s. (3s. 2d.)

### INDEX TO ALL REPORTS AND MEMORANDA PUBLISHED IN THE ANNUAL TECHNICAL REPORTS, AND SEPARATELY—

April, 1950 R. & M. No. 2600. 2s. 6d. (2s. 7½d.)

### INDEXES TO THE TECHNICAL REPORTS OF THE AERONAUTICAL RESEARCH COUNCIL—

December 1, 1936 — June 30, 1939.	R. & M. No. 1850.	1s. 3d. (1s. 4½d.)
July 1, 1939 — June 30, 1945.	R. & M. No. 1950.	1s. (1s. 1½d.)
July 1, 1945 — June 30, 1946.	R. & M. No. 2050.	1s. (1s. 1½d.)
July 1, 1946 — December 31, 1946.	R. & M. No. 2150.	1s. 3d. (1s. 4½d.)
January 1, 1947 — June 30, 1947.	R. & M. No. 2250.	1s. 3d. (1s. 4½d.)

*Prices in brackets include postage.*

Obtainable from

### HIS MAJESTY'S STATIONERY OFFICE

York House, Kingsway, LONDON, W.C.2    429 Oxford Street, LONDON, W.1  
P.O. Box 569, LONDON, S.E.1

13a Castle Street, EDINBURGH, 2    1 St. Andrew's Crescent, CARDIFF  
39 King Street, MANCHESTER, 2    Tower Lane, BRISTOL, 1  
2 Edmund Street, BIRMINGHAM, 3    80 Chichester Street, BELFAST

or through any bookseller.