

LIBRARY
ROYAL AIRCRAFT ESTABLISHMENT



MINISTRY OF SUPPLY

AERONAUTICAL RESEARCH COUNCIL
REPORTS AND MEMORANDA

Experiments with Static Tubes in a Supersonic Airstream Parts I and II

By

D. W. HOLDER, D.I.C., A.C.G.I., B.Sc., R. J. NORTH and A. CHINNECK,
of the Aerodynamics Division, N.P.L.

Crown Copyright Reserved

LONDON: HER MAJESTY'S STATIONERY OFFICE

1953

FOUR SHILLINGS NET

Experiments with Static Tubes in a Supersonic Airstream—Parts I and II

By

D. W. HOLDER, D.I.C., A.C.G.I., B.Sc., R. J. NORTH and A. CHINNECK,
of the Aerodynamics Division, N.P.L.

*Reports and Memoranda No. 2782**

July, 1950

PART I

Summary.—Systematic tests have been made at a Mach number of 1.6 on a family of static tubes. The variables which have been investigated are the shape of the nose, the distance of the holes downstream, and the inclination of the tube to the flow. Pressure measurements have also been made in the vicinity of a shock wave and close to a wall.

1. *Introduction.*—Although they are in everyday use in supersonic tunnels, few accounts of systematic experiments on the design of static tubes for measurements in supersonic flows seem to have been published. The present tests were not intended to be comprehensive, but to indicate at one Mach number (1.6) and one Reynolds number (3×10^4 based on the external diameter of the tube), the order of magnitude of the effects of some of the variables which are known to be important. It is hoped that the results will be of value as a basis for the further experiments which may be required for the design of static tubes for use under conditions which differ widely from those of the present tests.

2. *Apparatus and Technique.*—The tests were made in the National Physical Laboratory 9×3 in. Induced-Flow Wind-Tunnel R. & M. 2781¹ which for this purpose was fitted with a nozzle designed to give a Mach number of 1.6. It was decided to conduct the investigation at a Reynolds number similar to that of a tube which could be used during routine tests in a supersonic tunnel of average size, and the tubes were accordingly made from hypodermic tubing of 0.08 in. external diameter and 0.05 in. bore. The small size precluded the use of a design in which the nose shape and static-hole position could be adjusted, and a separate complete static tube was made for each of the 36 configurations tested.

The general arrangement of the tubes and details of the five nose shapes used are shown in Fig. 1. For each nose shape tests were made with the static holes 1, 3, 5, 7, 10, 15 and 20 external tube-diameters downstream of the shoulder (*i.e.*, the beginning of the parallel portion of the tube). Unless otherwise stated, four 0.01 in. diameter static holes in one plane normal to the axis of the tube were used in each case. The static tubes were made from carbon steel tubing because nickel tubing was found to be too soft, and the use of stainless steel tubing gave rise to difficulties in the drilling of the holes and the soldering of the nose pieces. When a small number of static tubes is required for use over a long period, however, stainless steel is usually to be preferred because of its freedom from corrosion.

* Published with the permission of the Director, National Physical Laboratory.

The tubes were supported in the middle of the tunnel on a traversing bar which could be moved along two axes normal to the stream, one normal to and the other parallel to the glass side walls of the tunnel. The side walls were themselves parallel to the flow and each tube was adjusted to be half-way between them by using a slip gauge. The position of the tube in a plane parallel to the side walls was observed from outside the tunnel by an incidence telescope. Using this technique it was possible, at zero yaw, to place the static holes of each tube in the same position in the tunnel to a high order of accuracy, and thus to minimise the effects of pressure variations in the working section. With the apparatus which was available, however, the tests at yaw had to be made by rotating the tube about an axis 7.06 in. downstream of the static holes. When the tube was at yaw, the static holes could still be brought back to the tunnel axis by using the traversing mechanism, but no compensation could be made for the movement of the holes parallel to the flow. This downstream movement was 0.24 in. at 15 deg yaw, and it was found in a separate experiment that the pressure variation along this length of the tunnel axis was small compared with the change of measured pressure due to yaw. The inclination of each tube to the stream was measured by the incidence telescope whilst the tunnel was running thus allowing for any change of inclination due to aerodynamic loading.

The datum pressure used in the tests was the static pressure at the wall of the working-section sufficiently far upstream to be uninfluenced by the presence of the tube and its supports. Pressure differences were measured on a U-tube containing water. Some of the pressures were also measured on a vertical tube containing mercury and using the total head of the undisturbed stream as datum pressure.

The flow was observed by a schlieren system based on two 9 in. diameter mirrors of 9 ft focal length, and photographs were taken with an exposure of the order of one microsecond.

One of the principal difficulties of the experiments was to determine the true static pressure in the tunnel at the position of the static holes. This pressure was estimated by making a measurement with a static tube with a 'long' ogival nose (Fig. 1) and with the static holes 40 diameters downstream. The validity of this procedure is to some extent confirmed by the agreement (*see* section 3 and Fig. 2) between the reading obtained with this tube and those obtained with the static holes 20 diameters downstream of the shoulder.

The dimensions of all the tubes were such that after reflection from the tunnel wall the Mach line from the nose struck the tube well downstream of the static holes.

3. *Observations at Zero Yaw.*—The measured static pressure is plotted in Fig. 2 against the distance of the static holes downstream of the shoulder for each of the nose shapes. Smooth curves have been drawn through the points as it is not known whether the scatter is due to real pressure changes or to small differences between the shapes of the tubes of a particular family (arising from errors of manufacture) or to experimental errors. It seems, however, that the measured pressure is substantially independent (to within say $\pm \frac{1}{2}$ per cent) of the nose shape and of the position of the holes if the holes are ten diameters or more downstream of the shoulder. With the holes 20 diameters downstream of the shoulder, the measured pressures are in good agreement with the pressure measured with the 40-diameter tube with the long ogival nose. An exception occurs in the case of the tube with the square nose which seems to read a pressure about $\frac{1}{2}$ per cent. lower than the remainder of the tubes.

4. *Measurements with a Dummy Support.*—Tests were made with a collar attached to the tube as shown in Fig. 3. This collar could be moved along the tube to vary its distance behind the static holes, and was used to simulate the effect on the pressure readings of a support. Since the main effect of the collar was to produce a shock wave which, in the absence of boundary-layer effects, would be nearly normal to the stream in the vicinity of the tube, it was thought that the observations would indicate also, at least qualitatively, the effects which would arise if the tube was used to make measurements in the vicinity of a near-normal shock wave produced by other means.

The variation of the measured pressure when the collar is moved upstream towards the static holes is shown in Fig. 3a and b, and photographs of the flow are reproduced in Fig. 4. Fig. 3a shows results obtained with the static holes 7 diameters behind the shoulder of the nose and indicates that, for the conical and ogival noses, the measured pressure begins to rise when the collar has been moved to within 14 diameters of the holes. For the square-nose the pressure rise does not begin until the collar has been moved to about 7 diameters behind the holes and is then more rapid than for the other two nose shapes. When the holes are 20 diameters behind the shoulder (Fig. 3b) the rate of pressure rise for the conical-nosed tube is comparable to that observed with the same nose shape but with the holes 7 diameters back. The pressure does not begin to rise, however, until the collar is 11 diameters behind the holes. The pressures measured with the 20-diameter ogival and square-nosed tubes rise more rapidly than those on the conical-nosed tube but the pressure rise does not begin until the collar is from 6 to 7 diameters downstream of the holes. The pressure rise for the 40-diameter ogival-nosed tube (Fig. 3b) is roughly as steep as for the 20-diameter tube but begins when the collar is a little further behind the holes.

Photographs of the flow round the 40-diameter and the 7-diameter ogival-nosed tubes are reproduced in Fig. 4a and b. In both cases the position of the collar ($L/D = 7$ and 14 respectively) is such that the measured pressure is just beginning to rise. Both photographs show that the boundary layer thickens or separates from the tube upstream of the collar; the thickening extending about 7 diameters upstream for the 40-diameter tube and about 14 diameters upstream for the 7-diameter tube. This indicates that the measured pressure does not begin to rise until the point at which the boundary layer begins to thicken corresponds approximately to the position of the pressure holes, and suggests that errors in pressure measurements ahead of a support or a shock wave may be avoided by observing the flow and ensuring that the static holes are always a few diameters ahead of the point at which the boundary layer thickens.

For the 40-diameter tube (Fig. 4a) the shock-wave pattern consists mainly of a strong shock, running from the point at which the boundary layer thickens, followed by a weaker shock running from near the collar. For the 7-diameter tube (Fig. 4b) the edge of the region of thickened or separated boundary-layer flow is concave and a weak shock occurs at the beginning of this region and is followed by a fan of compressions and by a relatively strong shock closer to the collar. This difference between the shock patterns for the two tubes is similar to that sometimes observed³ between the shocks at the rear of the local regions of supersonic flow on an aerofoil when the boundary layer is respectively turbulent and laminar. Indeed not only the different shock patterns but also the difference between the distances which the regions of separated flow extend upstream and the differences between the measured pressure gradients can be explained qualitatively in the light of previous investigations^{3,4} if it is assumed that the boundary layer is turbulent in the region of interaction with the shock wave on the 40-diameter tube and laminar on the 7-diameter tube. Observations of the flow round the other tubes showed that when the pressure rise was of the rapid type the flow pattern was similar to that shown in Fig. 4a and that when it was of the more gradual type the flow was similar to that shown in Fig. 4b. It seems reasonable to assume, therefore, that for all cases tested a rapid pressure rise corresponds to a turbulent and a gradual rise to a laminar boundary layer. It is, however, not clear why the boundary layer on the 20-diameter conical-nosed tube (Fig. 3b) should be laminar whilst that on the 20-diameter ogival-nosed tube is turbulent. It should also be remembered that the Reynolds number (based on distance from the nose) in the region of the interaction between the shock and the boundary layer decreased as the collar was moved upstream.

For the 40-diameter tube the measured semi-angle of the conical region ahead of the collar is 20 deg and the measured angle of the shock running from the apex is 46 deg. This value is in excellent agreement with that calculated for the flow round a true cone with the measured apex angle. The calculated pressure coefficient p/H_0 at the surface of this cone is 0.385 and, apart from a region close to the collar, this is seen (Fig. 3b) to be in fair agreement with that

measured close to the axis of the conical region. It seems, therefore, that for the 40-diameter tube the flow separates ahead of the collar and produces a region of more or less constant pressure which behaves like a true cone as far as the external flow is concerned.

The generator of the conical region is not straight but concave towards the stream for the 7-diameter tube. The measured semi-angle at the apex is about 11 deg and the corresponding theoretical shock angle for a cone of this angle is 40 deg. This value does not agree with the measured shock angle (31 deg) nor does the calculated pressure coefficient (0.281) agree with that measured at the tube. These discrepancies are, however, not surprising in view of curved shape of the edge of the region; this curvature produces a fan of compressions which explains the more gradual pressure rise measured with the 7-diameter tube.

The conical separation which may occur when a tube is passed through a near-normal shock wave has been examined in greater detail and over a wider range of conditions by Lukasiewicz (R. & M. 2669⁶) who gives examples of a flow which is thought to be similar to that shown in Fig. 4a. He does not, however, appear to have encountered a flow similar to that shown in Fig. 4b.

5. *Measurements near a Wall.*—The change of reading which occurs as the static tube is moved towards the tunnel wall is shown in Fig. 5 and the boundary-layer profile on the wall measured by a pitot-tube of 0.028 in. external diameter and 0.012 in. bore is shown in Fig. 6. The static-pressure measurements were made with the holes in planes at 45 deg to the wall.

Fig. 5a shows that as the 7-diameter square-nosed tube is moved towards the wall the measured pressure rises to a peak at A and then falls and rises again to a second but lesser peak B. Schlieren observations showed that the peak A occurred when the bow wave from the nose passed over the pressure holes after reflection from the wall and that the peak B occurred when the reflection of a second shock arising from a local separation and reattachment of the flow⁶ close to the nose met the tube at the static holes. The fall of pressure between the peaks A and B is thought to be due to the reflection of the expansion between the two shock waves. When the tube has a long ogival nose there is a single bow wave only, and when its reflection strikes the tube close to the pressure holes the measured pressure rises and then falls gradually as shown in Fig. 5b.

For the 40-diameter tube with the long ogival nose, no reflections of the bow wave could be observed in the vicinity of the pressure holes. The measured pressure (Fig. 5c) again tends to rise as the wall is approached, but the rise is more gradual than for the 7-diameter tube.

6. *Tests at Yaw.*—The effect of yaw on the reading of the family of tubes with long ogival noses is shown in Fig. 7 and the effect of nose shape on the sensitivity to yaw of the 10-diameter family is shown in Fig. 8. In both series of tests the static holes were in planes at 45 deg to the plane of yaw. At small incidences the sensitivity to yaw does not depend very much on either nose shape or hole position and, as a general conclusion, it seems that the reading is roughly 1 per cent low for a yaw of from 3 to 4 deg. This value is comparable to that measured⁷ at low speeds for the static sides of the N.P.L. standard pitot-static tube and of a modified form of pitot-static tube described⁷ by Ower.

At larger incidences there is a larger difference between the curves, particularly between those for different tube length. The reason for this is not known, but it was found from schlieren observations that the kinks in some of the curves corresponded to the onset of a separation of the flow from one side of the tube. Examples are shown in the photographs reproduced in Fig. 11 for the 10-diameter tube with the long ogival and conical noses. In Fig. 11a, at 6 deg yaw, the flow appears to adhere to the tube over its whole length but at 15 deg (Fig. 11b) a separation occurs from the nose on one side. There is a similar difference between Figs. 11c and 11d.

Fig. 9 shows that, when four static holes are used, the sensitivity to yaw is not affected appreciably by changing the positions of the holes relative to the plane of yaw. When two static holes (180 deg apart) are used, however, the position of the holes has a large effect (Fig. 10), the sensitivity being smallest when both holes are in the plane of yaw.

7. *Conclusions.*—The following conclusions seem to apply under the conditions for which the tests were made (*i.e.*, $M = 1.6$, $R_{\text{diam}} = 3 \times 10^4$):—

- (i) To within $\pm \frac{1}{2}$ per cent, the pressure reading is independent of the nose shape and of the position of the static holes when the holes are more than 10 tube-diameters behind the shoulder of the nose.
- (ii) Large changes in measured pressure may occur if there is a support or a strong shock wave close behind the pressure holes. The magnitude of these changes and the position of the support, or of the shock wave, relative to the pressure holes at which they begin depend on the nose shape and on the distance of the holes behind the nose. It is thought that this effect arises because the nose shape and the length of tube upstream of the holes affect the state of the boundary layer in the vicinity of the support or shock wave. There is evidence that errors of this type may be avoided by observing the flow, and ensuring that the boundary layer does not begin to thicken less than one or two tube-diameters behind the holes.
- (iii) Errors may arise in static-pressure measurements close to a wall from the reflection on to the tube of the bow wave from the nose. The error is smaller for a pointed than for a bluff nose, and may be avoided by ensuring that the reflected bow wave strikes the tube behind the pressure holes.
- (iv) At small angles of yaw, the nose shape and the position of the static holes do not have a large effect on the sensitivity to yaw. The measured pressure is 1 per cent lower than the pressure at zero yaw for an inclination of from 3 to 5 deg.
- (v) When four pressure holes spaced at 90-deg intervals round the tube are used, the position of the holes relative to the plane of yaw has little effect on the sensitivity to yaw.
- (vi) When two holes spaced at 180 deg intervals are used, the sensitivity to yaw with the holes in the plane of yaw is of opposite sign and smaller than with the holes at 90 deg to the plane of yaw.

PART II

Summary.—A family of flat-nosed pitot-tubes has been tested at Mach numbers of 1.6 and 1.8. At both Mach numbers it was found that no change of reading could be detected when the ratio of the external diameter to the bore was varied from 2 to 16. The Mach number calculated from the pitot pressure on the assumption that the bow wave ahead of the pressure hole was normal to the stream is, to within about $\pm \frac{1}{2}$ per cent, equal to that calculated from the reading of a static tube.

1. *Introduction.*—In the analysis of pitot-tube readings obtained in supersonic flows it is usual to assume that the bow wave is normal to the stream tube leading to the pressure hole, and that along this stream tube losses of total head occur only through the bow wave. In practice the bow wave is always detached from the nose and curved so that the assumption of a normal shock is not fully justifiable. It seems, however, that it may be sufficiently accurate for experimental purposes particularly if the diameter of the pressure hole is small compared with the external diameter of the tube. A tube of this type would, however, be inconvenient for many purposes as it would produce a large disturbance if the external diameter were large, or would be sluggish in operation if the pressure hole were very small. The present experiment was made to investigate the effect on the reading of the ratio of the external diameter to the bore.

2. *Apparatus.*—Six pitot-tubes were tested in the National Physical Laboratory 9×3 in. Induced-Flow Wind-Tunnel. The bore d (Fig. 12) was kept constant at $1/32$ in. and the external diameter D varied from $1/16$ to $\frac{1}{2}$ in. The tubes were mounted on a sting connected to a traversing mechanism which enabled them to be yawed, and translated along three mutually perpendicular axes. Although preliminary measurements showed that the pitot and static pressures in the tunnel were uniform in the vicinity of the tube, each tube was adjusted so that the apex of its detached bow wave, as observed by a direct-shadow method, was at the same point in the tunnel. The static pressure at this point was measured with an 0.08 in. diameter tube fitted with four 0.01 in. diameter pressure holes ten tubes behind the shoulder of its ogival nose. The measurements described in the first part of this report suggested that the reading of a static-tube of this design was a good approximation to the true static pressure. The datum for all pressure measurements was the pressure measured at a pitot-tube upstream of the contraction. Explorations (R. & M. 2781¹) upstream of the contraction had shown that variations of total head across the tunnel here could be ignored for the purpose of the present experiment.

3. *Notation.*

- H_0 Pitot-pressure measured upstream of the contraction
- H Pitot-pressure measured in the working-section
- p Static-pressure measured in the working-section
- M_1 Mach number calculated from H/H_0 assuming a normal shock
- M_2 Mach number calculated from p/H_0 .

It was assumed that the pitot-tube upstream of the contraction measured the true total head there, and that no loss of total head occurred between the contraction and the working-section. The total head of the undisturbed stream in the working-section was, therefore, taken as H_0 , and the Mach numbers M_1 and M_2 calculated from the following formulae* taking $\gamma = 1.40$.

$$\frac{H}{H_0} = \frac{(\gamma + 1)^{(\gamma+1)/(\gamma-1)} M_1^{2\gamma/(\gamma-1)}}{(2 + (\gamma - 1)M_1^2)^{\gamma/(\gamma-1)} [2\gamma M_1^2 - (\gamma - 1)]^{1/(\gamma-1)}} \quad \dots \quad (1)$$

$$\frac{p}{H_0} = \left(\frac{2}{2 + (\gamma - 1)M_1^2} \right)^{\gamma/(\gamma-1)} \dots \quad (2)$$

4. *Results.*—The results obtained when the tunnel was fitted with liners designed to give Mach numbers of 1.6 and 1.8 are set out in Tables 1 and 2 respectively.

TABLE 1
Measurements at $M = 1.6$ (Nominal)
 $p/H_0 = 0.228$ $M_2 = 1.621$

D/d	H/H_0	M_1
2	0.891	1.612
4	0.891	1.612
8	0.891	1.612
10	0.891	1.612
12	0.891	1.612
16	0.891	1.612

* Values calculated from these formulae are tabulated in Refs. 8 and 9.

TABLE 2
Measurements at $M = 1.8$ (Nominal)
 $p/H_0 = 0.180$ $M_2 = 1.778$

D/d	H/H_0	M_2
2	0.818	1.788
4	0.818	1.788
8	0.818	1.788
10	0.818	1.788
12	0.818	1.788
16	0.818	1.788

The 1/16 in. diameter tube was also tested at yaw in the $M = 1.6$ liners. The results are shown in Fig. 2.

5. *Discussion.*—Tables 1 and 2 show that at both Mach numbers the pitot pressure is, to a high order of accuracy, independent of variations of the ratio of external diameter to bore within the limits of 2 and 16. This may no longer be true at higher Mach numbers because the curvature of the bow wave will then be greater. A ratio of 7 seems to have been used in the Köchel tunnels¹¹ which ran at Mach numbers up to about 4. The agreement between the Mach numbers calculated from the pitot and static measurements made in the present tests is considered to be satisfactory in view of the possible sources of inaccuracy in an experiment of this type, and supports the usual assumption of a normal shock ahead of the tube.

The results plotted in Fig. 2 show that the reading of the 1/16 in. diameter pitot-tube is not sensitive to yaw up to about 12 deg.

REFERENCES

- | <i>No.</i> | <i>Author</i> | <i>Title, etc.</i> |
|------------|---|---|
| 1 | D. W. Holder and R. J. North | The 9 × 3 in. Induced-flow High-speed Wind Tunnel at the National Physical Laboratory. R. & M. 2781. June, 1949. |
| 2 | H. H. Pearcey | Types of Shock Waves observed on Aerofoils at High Subsonic Speeds. (In preparation.) |
| 3 | H. W. Liepmann | The Interaction between Boundary Layer and Shock Waves in Transonic Flow. <i>J. Ae. Sci.</i> Vol. 13, No. 12, p. 623. A.R.C. 10479. December, 1946. |
| 4 | J. Ackeret, F. Feldmann and N. Rott | Investigations on Compression Shocks and Boundary Layers in Fast Moving Gases. (Institut für Aerodynamik ETH Zürich, No. 10, 1946). A.R.C. 10,044. |
| 5 | J. Lukasiewicz | Conical Flow as a Result of Shock and Boundary Layer Interaction on a Probe. R. & M. 2669. September, 1948. |
| 6 | D. W. Holder, R. J. North and A. Chinneck | Observations of the Bow Waves of Blunt-nosed Bodies of Revolution in Supersonic Airstreams. A.R.C. 12,495. August, 1949. (To be published.) |
| 7 | E. Ower | <i>The Measurement of Airflow.</i> Chapman and Hall. 1927. |
| 8 | R. Harrop and P. I. Bright .. | Tables for Compressible Air Flow Calculations, Part IV. A.R.C. 10,910. July, 1947. (Unpublished.) |
| 9 | D. E. Lindop, E. E. Regan and R. Harrop | Tables for Compressible Air Flow Calculations, Part III. A.R.C. 11,118. March, 1947. (Unpublished.) |
| 10 | P. R. Owen, | Note on the Apparatus and Work of the W.V.A. Supersonic Institute at Köchel, S. Germany. A.R.C. 9361. November, 1945. (Unpublished.) |

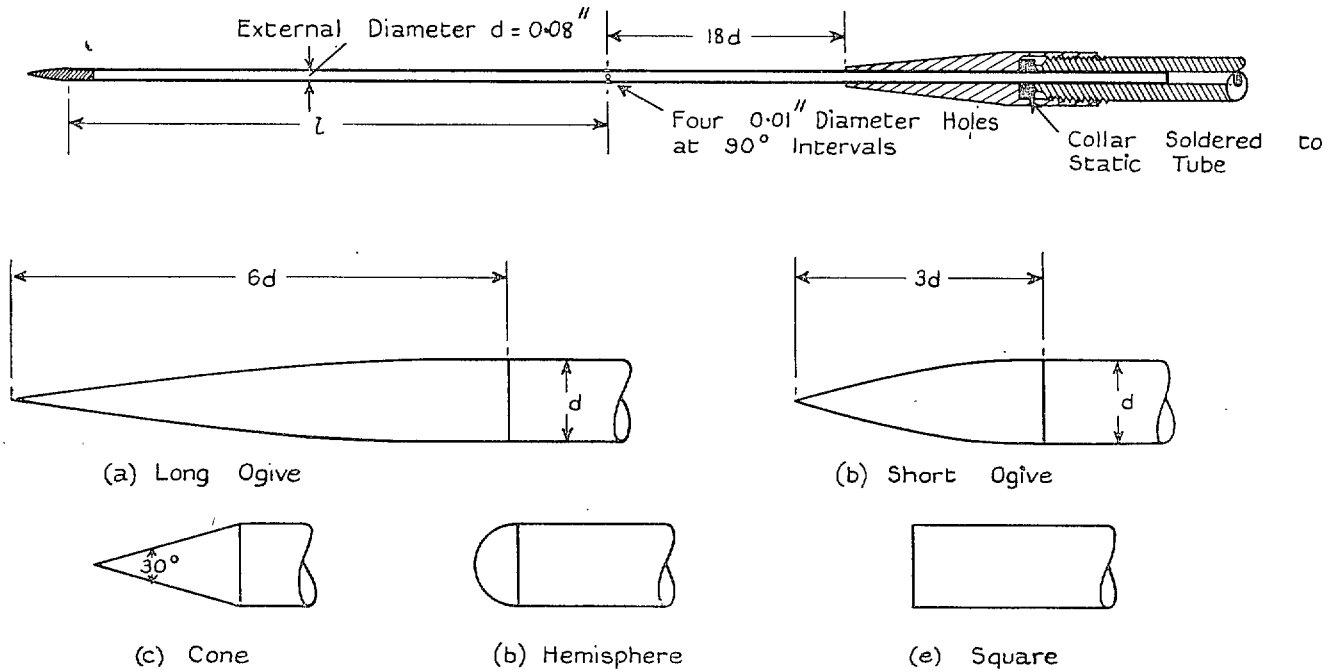

FIG. 1. General arrangement of the static tubes and the nose shapes tested.

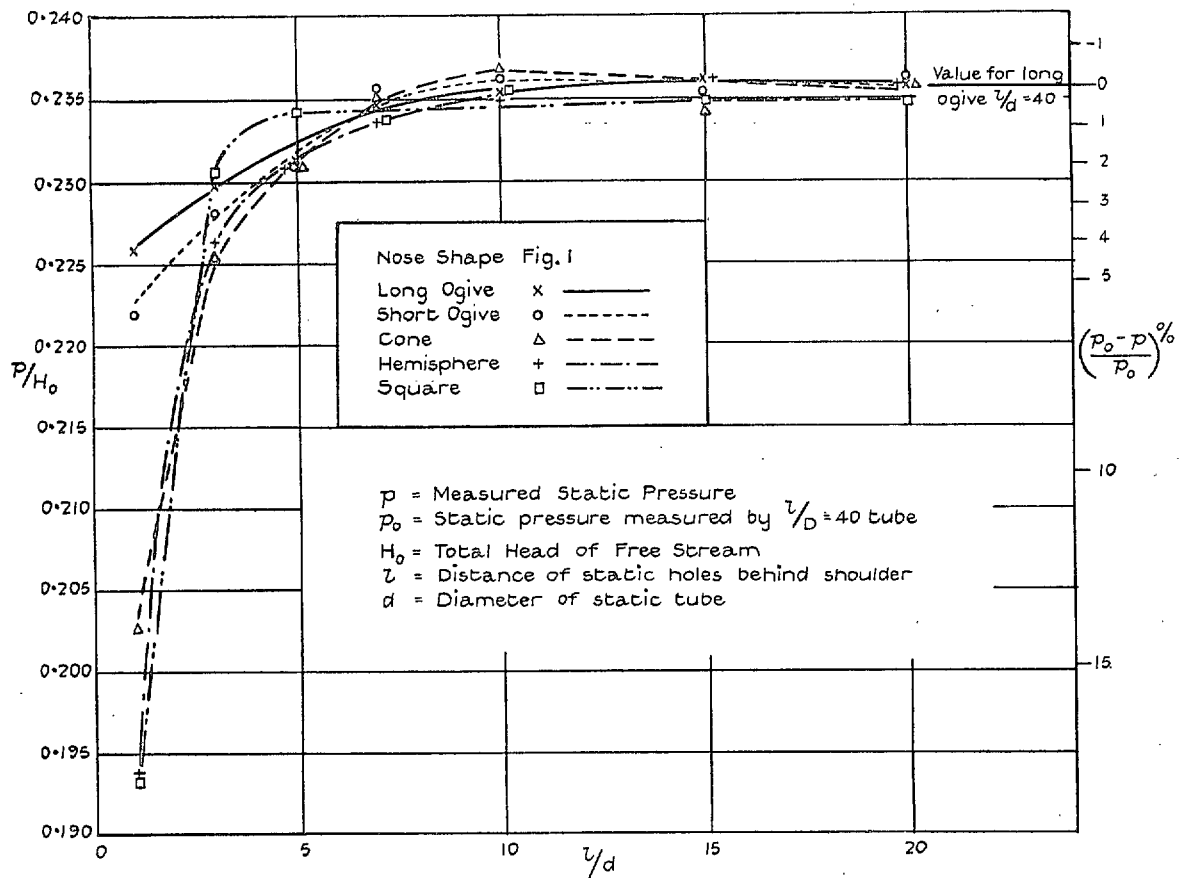
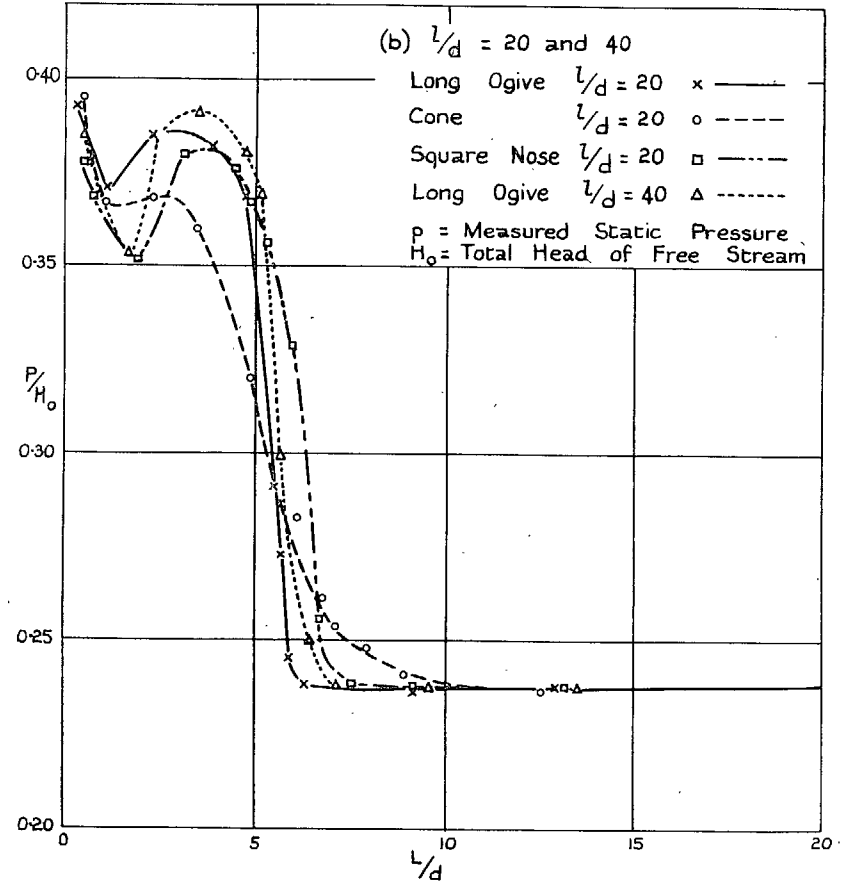
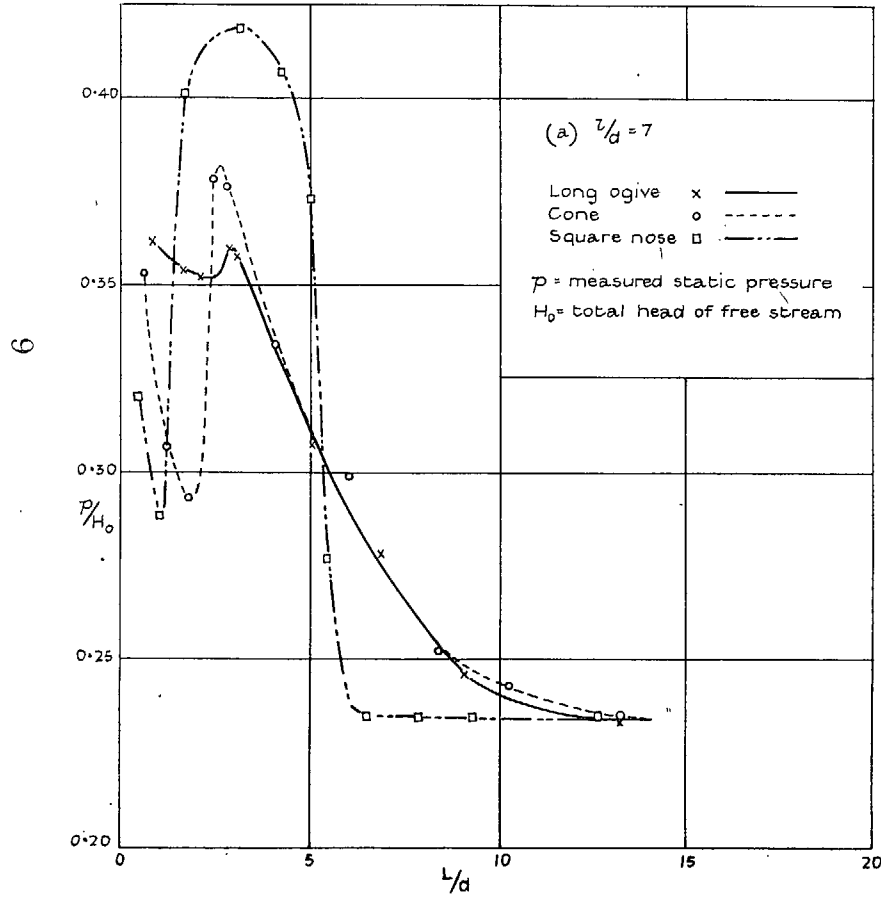
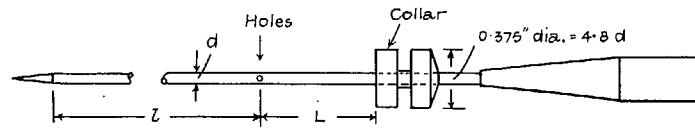
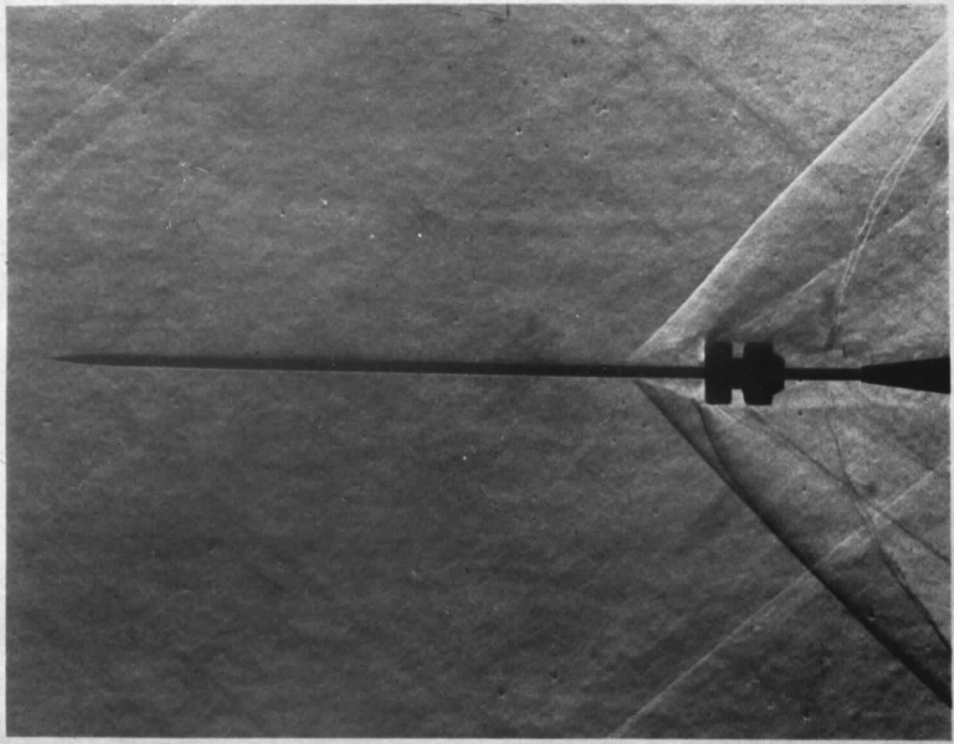

FIG. 2. Variation of static-pressure reading with position of static holes and nose shape at $M = 1.6$.



FIGS. 3a and b. Effect of dummy support on the reading of a static tube.



(a) Long Ogive $l/d = 40$

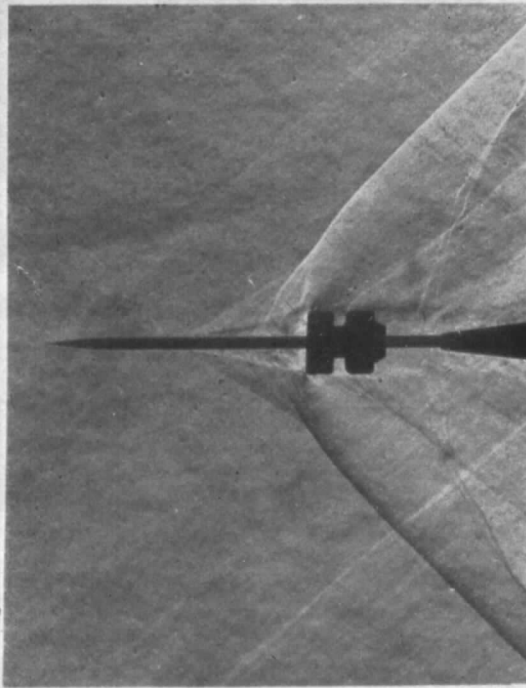

(b) Long Ogive $l/d = 7$

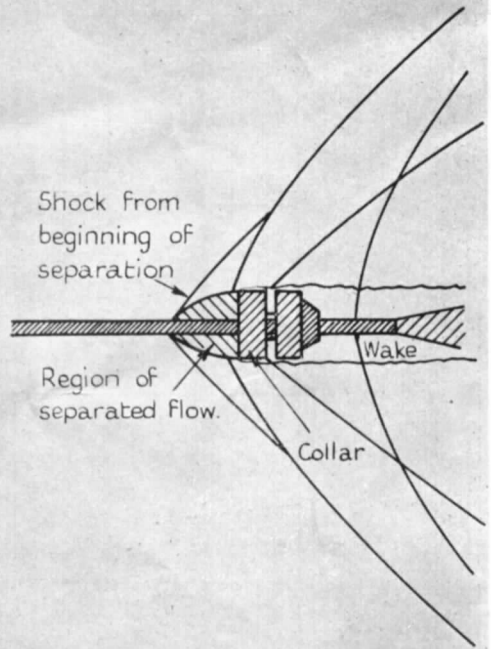

(c) Sketch of Flow For $l/d = 40$.

FIG. 4. Interaction of a shock wave with the boundary layer on a static-tube.

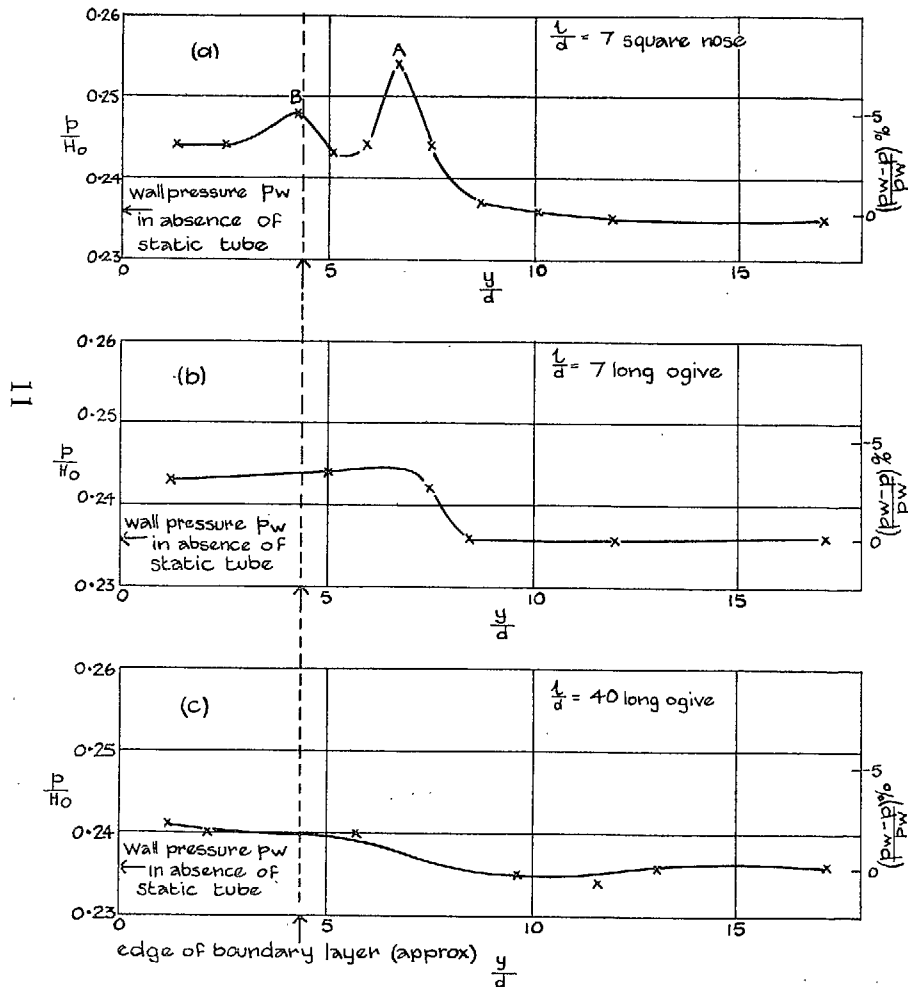
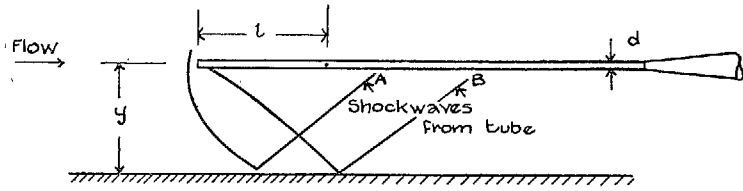

FIG. 5. Static-tube reading near a wall.

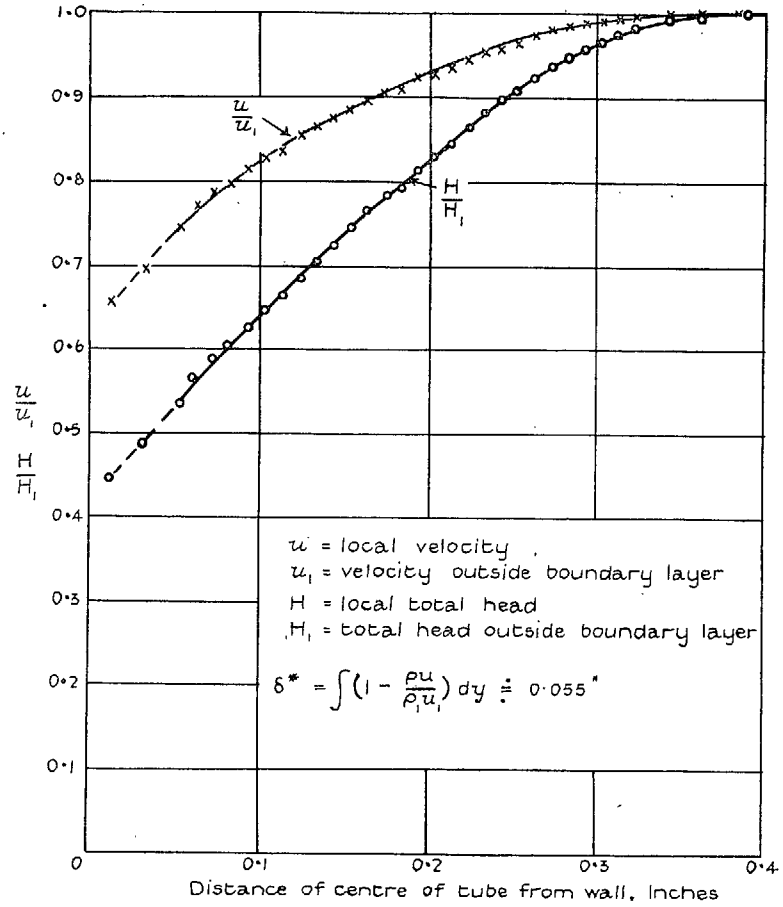

FIG. 6. Boundary-layer profile on the tunnel wall opposite the static-tube (See Fig. 5).

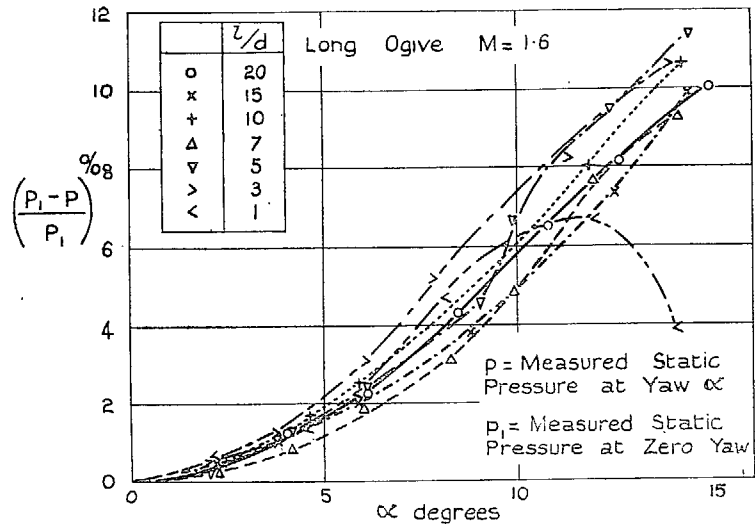

FIG. 7. Effect on sensitivity to yaw of the position of the static holes relative to the nose.

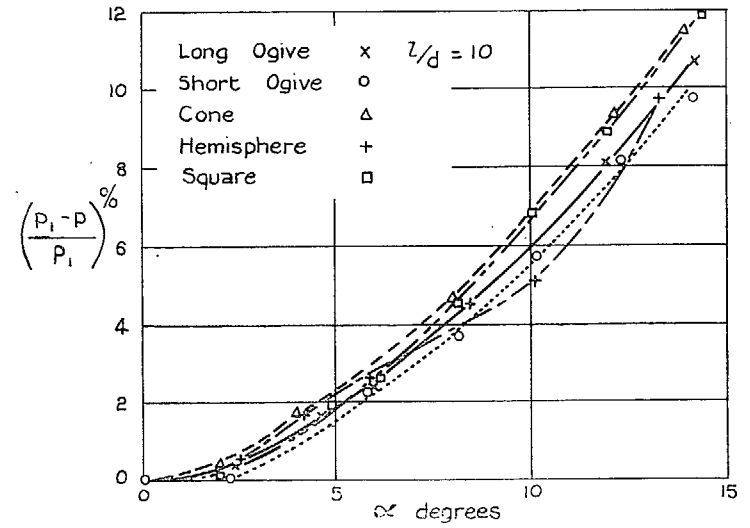

FIG. 8. Effect on sensitivity to yaw of the shape of the nose.

12

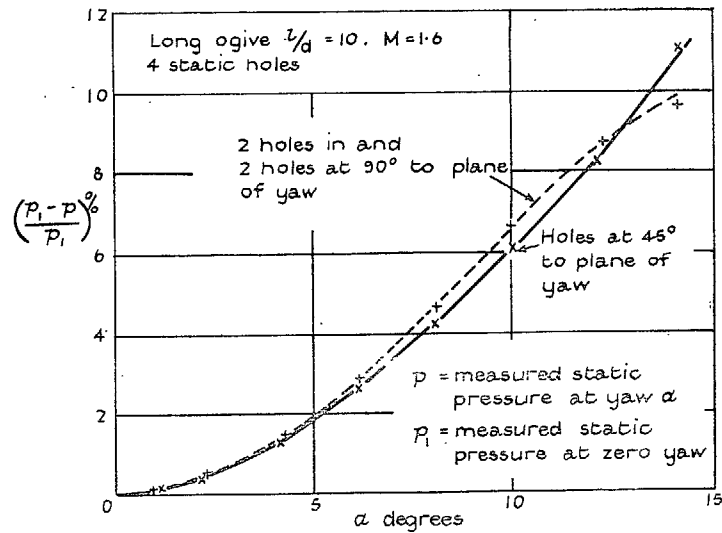

FIG. 9. Effect on sensitivity to yaw of the position of 4 static holes relative to the plane of yaw.

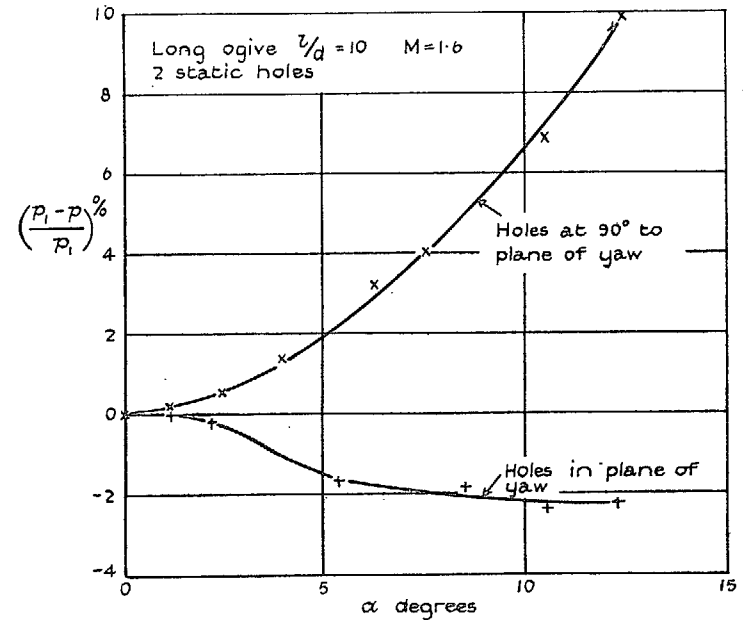

FIG. 10. Effect on sensitivity to yaw of the position of 2 static holes relative to the plane of yaw.

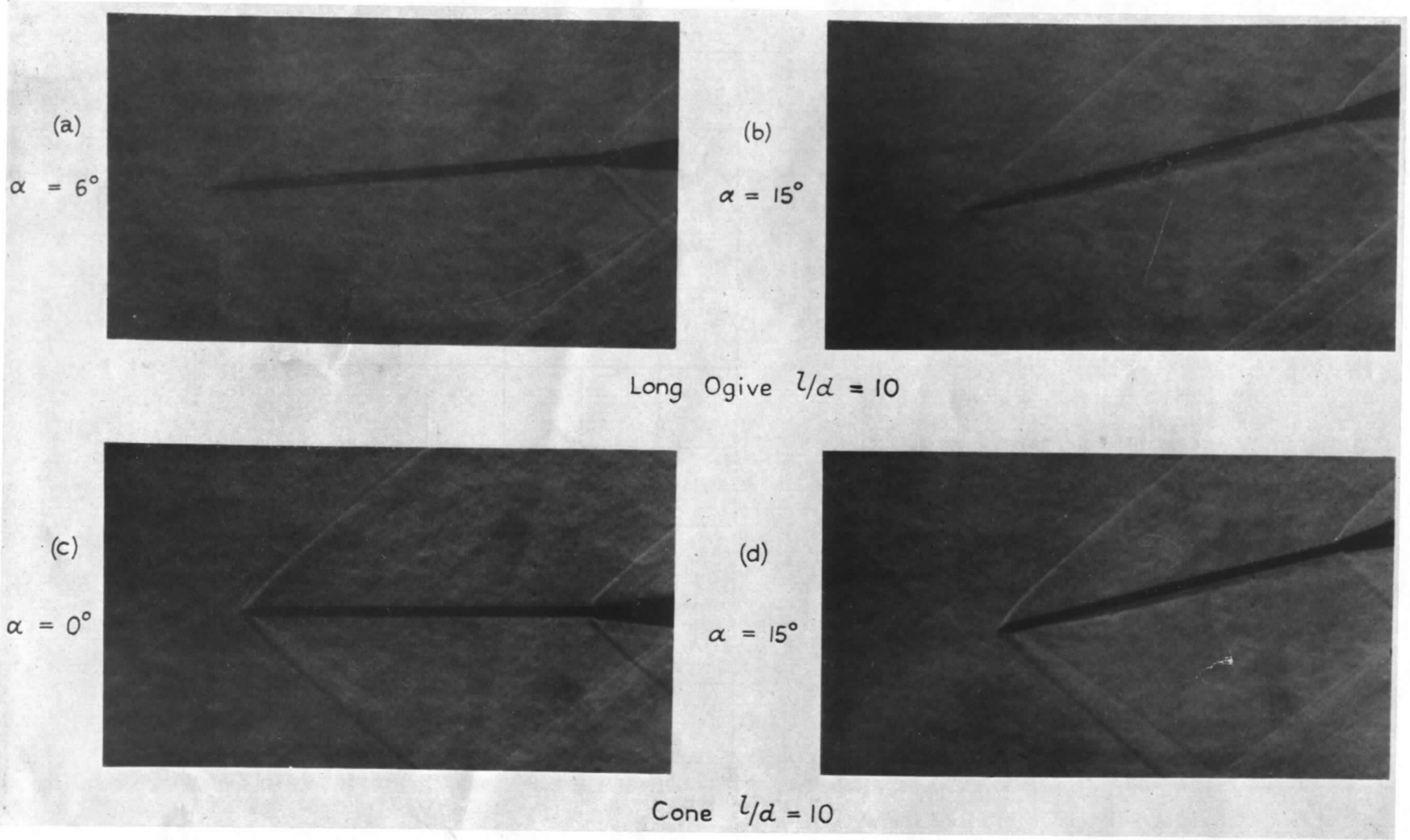

FIG. 11. Examples of separation on yawed static-tubes.

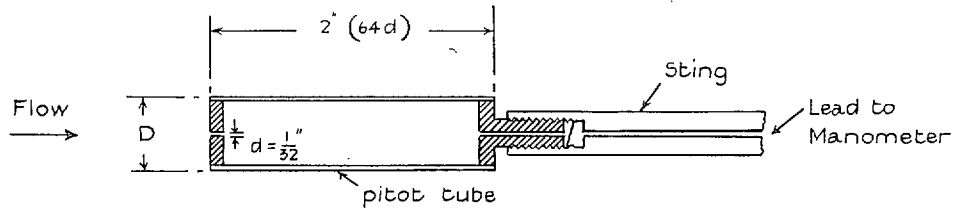

FIG. 12. Detail of tubes tested.

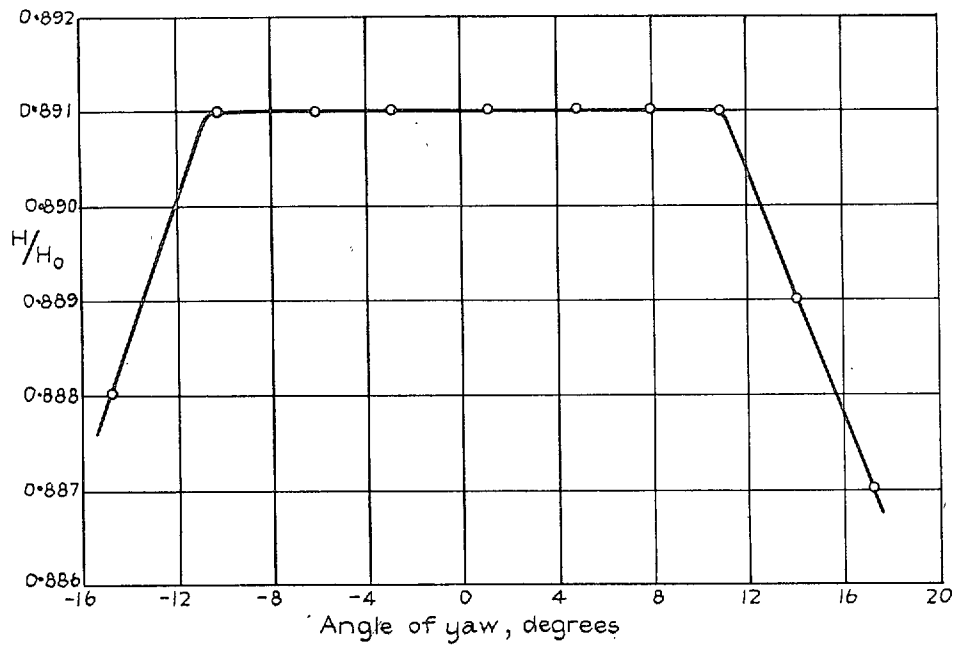

FIG. 13. Effect of yaw on the reading of the 1/16 in. diameter pitot-tube at $M = 1.6$.

Publications of the Aeronautical Research Council

ANNUAL TECHNICAL REPORTS OF THE AERONAUTICAL RESEARCH COUNCIL (BOUND VOLUMES)

- 1936 Vol. I. Aerodynamics General, Performance, Airscrews, Flutter and Spinning. 40s. (40s. 9d.)
Vol. II. Stability and Control, Structures, Seaplanes, Engines, etc. 50s. (50s. 10d.)
- 1937 Vol. I. Aerodynamics General, Performance, Airscrews, Flutter and Spinning. 40s. (40s. 10d.)
Vol. II. Stability and Control, Structures, Seaplanes, Engines, etc. 60s. (61s.)
- 1938 Vol. I. Aerodynamics General, Performance, Airscrews. 50s. (51s.)
Vol. II. Stability and Control, Flutter, Structures, Seaplanes, Wind Tunnels, Materials. 30s. (30s. 9d.)
- 1939 Vol. I. Aerodynamics General, Performance, Airscrews, Engines. 50s. (50s. 11d.)
Vol. II. Stability and Control, Flutter and Vibration, Instruments, Structures, Seaplanes, etc.
63s. (64s. 2d.)
- 1940 Aero and Hydrodynamics, Aerofoils, Airscrews, Engines, Flutter, Icing, Stability and Control,
Structures, and a miscellaneous section. 50s. (51s.)
- 1941 Aero and Hydrodynamics, Aerofoils, Airscrews, Engines, Flutter, Stability and Control, Structures.
63s. (64s. 2d.)
- 1942 Vol. I. Aero and Hydrodynamics, Aerofoils, Airscrews, Engines. 75s. (76s. 3d.)
Vol. II. Noise, Parachutes, Stability and Control, Structures, Vibration, Wind Tunnels.
47s. 6d. (48s. 5d.)
- 1943 Vol. I. (In the press.)
Vol. II. (In the press.)

ANNUAL REPORTS OF THE AERONAUTICAL RESEARCH COUNCIL—

1933-34	1s. 6d. (1s. 8d.)	1937	2s. (2s. 2d.)
1934-35	1s. 6d. (1s. 8d.)	1938	1s. 6d. (1s. 8d.)
April 1, 1935 to Dec. 31, 1936.	4s. (4s. 4d.)	1939-48	3s. (3s. 2d.)

INDEX TO ALL REPORTS AND MEMORANDA PUBLISHED IN THE ANNUAL TECHNICAL REPORTS AND SEPARATELY—

April, 1950 - - - - - R. & M. No. 2600. 2s. 6d. (2s. 7½d.)

AUTHOR INDEX TO ALL REPORTS AND MEMORANDA OF THE AERONAUTICAL RESEARCH COUNCIL—

1909-1949 - - - - - R. & M. No. 2570. 15s. (15s. 3d.)

INDEXES TO THE TECHNICAL REPORTS OF THE AERONAUTICAL RESEARCH COUNCIL—

December 1, 1936—June 30, 1939.	R. & M. No. 1850.	1s. 3d. (1s. 4½d.)
July 1, 1939—June 30, 1945.	R. & M. No. 1950.	1s. (1s. 1½d.)
July 1, 1945—June 30, 1946.	R. & M. No. 2050.	1s. (1s. 1½d.)
July 1, 1946—December 31, 1946.	R. & M. No. 2150.	1s. 3d. (1s. 4½d.)
January 1, 1947—June 30, 1947.	R. & M. No. 2250.	1s. 3d. (1s. 4½d.)
July, 1951. - - - - -	R. & M. No. 2350.	1s. 9d. (1s. 10½d.)

Prices in brackets include postage.

Obtainable from

HER MAJESTY'S STATIONERY OFFICE

York House, Kingsway, London, W.C.2; 423 Oxford Street, London, W.1 (Post
Orders: P.O. Box 569, London, S.E.1); 13a Castle Street, Edinburgh 2; 39 King Street,
Manchester 2; 2 Edmund Street, Birmingham 3; 1 St. Andrew's Crescent, Cardiff;
Tower Lane, Bristol 1; 80 Chichester Street, Belfast or through any bookseller.