

LIBRARY
ROYAL AIRCRAFT ESTABLISHMENT
BEDFORD.

C. P. No. 729

C. P. No. 729



MINISTRY OF AVIATION

AERONAUTICAL RESEARCH COUNCIL

CURRENT PAPERS

Free-Flight Tests of Vortex Generator Configurations at Transonic Speeds.

By

J. B. W. Edwards

LONDON HER MAJESTY'S STATIONERY OFFICE

1966

PRICE 5s 6d NET

December, 1962

FREE-FLIGHT TESTS OF VORTEX GENERATOR CONFIGURATIONS
AT TRANSONIC SPEEDS

by

J.B.W. Edwards

SUMMARY

Tests have been made to investigate the effectiveness of vortex generators in alleviating the adverse effects of shock-induced boundary layer separation. The variation in effectiveness of a flap control on an unswept wing in the transonic speed range was taken as a representative example of such effects since it lends itself easily to simple and reliable measurements by the free-flight technique. Most of the configurations were successful in improving the transonic effectiveness, although one made matters worse. Three configurations maintained the improvement through to supersonic speeds where generators were not expected to have a beneficial effect. The results bear out previous findings remarkably well particularly those of small scale tests at N.P.L. This applies to both successful and unsuccessful configurations.

LIST OF CONTENTS

	<u>Page</u>
1 INTRODUCTION	3
2 DESCRIPTION OF THE VORTEX GENERATORS AND THE METHOD OF TESTING	3
3 RESULTS AND DISCUSSION	4
3.1 Counter-rotating generators	5
3.2 Co-rotating generators	7
3.3 Biplane generators and tandem row generators	8
4 COMPARISON BETWEEN THE FREE-FLIGHT RESULTS AND PREVIOUS RESULTS DESCRIBED IN REF.1	9
5 CONCLUSIONS	10
LIST OF SYMBOLS	11
LIST OF REFERENCES	12

TABLE 1 - Details of the vortex-generator configurations

ILLUSTRATIONS - Figs.1-15	-
DETACHABLE ABSTRACT CARDS	-

LIST OF ILLUSTRATIONS

	<u>Fig.</u>
Photograph of a typical rolling effectiveness model	1
Wing details	2
Photographs of the vortex-generator configurations	3
Control effectiveness curves: Configurations 1-9	4-12
Histograms for the comparison of effectiveness	13a, b, c
Typical vortex path in the plane normal to the stream for counter-rotating generators and notation	14
Illustration of vortex paths of counter and co-rotating generators	15a, b

1 INTRODUCTION

One of the distinguishing features of early flights at transonic speeds was the number of adverse characteristics - buffeting, loss of control effectiveness, reduction in stability - which resulted from a single flow phenomenon; shock-wave induced separation of the boundary layer. A number of design devices have been proposed to overcome or alleviate shock-induced separation effects, among them the use of small vanes set normal to the appropriate surface in such a fashion that their trailing vortex system would re-energise the boundary layer and thus enable it to withstand higher adverse pressure gradients before separating. Early designs of these so-called vortex generators were based almost wholly on the process of cut and try, there being little or no qualitative or quantitative understanding of the mechanism underlying their operation.

In an attempt to rectify this situation the Aerodynamics Division of the National Physical Laboratory instituted a systematic experimental and theoretical investigation into the behaviour of various vortex-generator configurations and a parallel investigation was conducted at the Royal Aircraft Establishment using the free-flight technique in order to extend the N.P.L. work to Reynolds numbers more representative of full-scale flight. The first configurations were chosen to check N.P.L. results on what at the time seemed key points and to check that differences between N.P.L. results and results obtained by the National Aeronautical Establishment of Canada were due to generator design rather than scale effect. Other configurations were added later making nine variations, all were chosen before the development of the theoretical basis for vortex generators due to Pearcey¹. For this reason they form an adequate rather than ideal foundation for comparison with theory. However most of them are suitable for comparison with N.P.L. results (Section 4).

The transonic rolling effectiveness of flap controls on a three-winged model was used as a standard for comparison with results from identical models which had vortex generators fitted to the upper surface of the wings. This particular method was chosen because it had been shown in Ref.5 that a wing plus flap control of similar planform and section suffered a large loss in control effectiveness at transonic speeds caused by shock-wave induced separation of the flow over the control surface.

2 DESCRIPTION OF THE VORTEX GENERATORS AND THE METHOD OF TESTING

The design of the initial configurations was determined in consultation with Aerodynamics Division, N.P.L. on the basis of work then in progress which has subsequently been reported in Ref.1. As the test programme developed additional configurations were added to investigate certain specific points. In order to keep the number of test vehicles involved to a manageable quantity the tests were confined to investigating the effects of blade spacing, blade length and direction of rotation of the vortices, together with two rather special configurations. Accordingly all the generators were made the same height and thickness (1% of wing chord and $7\frac{1}{2}\%$ blade thickness/chord ratio). The blades were all flat plates of uniform thickness, no attempt was made to give them aerofoil shapes. The blade arrangements are illustrated in Table 1 which gives all the relevant dimensions. Photographs of the actual generators mounted on a wing are shown in Fig.3. The generators were manufactured by machining the blades from solid bars leaving them mounted on a base. The strip of blades was then mounted on the wing by embedding the base in the wing surface leaving only the blades protruding.

The wing chosen for the tests was unswept and untapered and had a 10% thick R.A.E. 102 section: the aspect ratio was 4. The wing had a full span flap (hinge line at 0.75c) deflected downwards through an angle of 4° . The

generators were mounted on the upper surface of the wing at 0.5c (0.65c on configurations 2 and 3) across the whole span. This wing flap combination was chosen because it had been tested in the high-speed wind-tunnel at N.P.L.⁵ where it was shown to have very marked separation effects, causing an almost complete loss of control effectiveness at transonic speeds. Schlieren photographs of the flow show clearly the shock-wave causing separation of the boundary-layer. At the trough in the control-effectiveness curve, the offending shock is situated between 0.75c and 0.80c, that is just behind the hinge line. This is of great importance when considering the transonic effectiveness of the generators, for they are then some 25 blade heights upstream of the shock.

Details of the wing and generator positions are illustrated in Fig.2 and a photograph of a complete test vehicle is shown in Fig.1.

Each test vehicle was of the non-separating type, i.e. the rocket motor formed the body of the vehicle. The three wings were attached at the rear and were equally spaced round the circumference of the tube. The nose of the vehicle was of perspex and contained the telemetry equipment by which the rolling motion of the vehicle was measured during its flight.

The rocket motor boosted the vehicle to a maximum Mach number of 1.35 in about 2 seconds after which it coasted for about 10 seconds before impact. It was during this coasting period that the measurements were made.

The velocity, trajectory and the rate of roll were obtained for each flight from radio-Doppler, kinetheodolites and the roll telemetry records. Full details of these measurements are given in Ref.3.

From this information, together with the measured roll moment of inertia and an estimated value of the damping in roll of the model⁶ the steady-state wing-tip helix angle $\frac{Pb}{2v}$ was computed as a function of Mach number. The non-dimensional quantity $\frac{Pb}{2v\xi}$ was chosen as the best method of presenting the rolling effectiveness of the models, where ξ is the angular deflection of the flap controls. The wing-tip helix angle is usually less than one degree, thus there is no question of flow separations caused by incidence effects obscuring the results.

The wings were sufficiently stiff to reduce aeroelastic effects to negligible proportions over the Mach number range investigated.

3 RESULTS AND DISCUSSION

The rolling effectiveness, $\frac{Pb}{2v\xi}$ for each of the test models with vortex generators is plotted against Mach numbers in Figs.4 to 12. The effectiveness curve for the test model with no generators is superimposed on each of the figures to act as a reference level for ease of comparison.

Before considering the configurations individually it is necessary to look briefly into the mechanism of vortex generators and the way in which they effect shock-induced boundary-layer separation. The vanes of the generators set at an incidence to the main stream, behave like aerofoils and the circulation about them causes trailing vortices to be shed which are transported across the wing in a roughly chordwise direction by the main stream. These vortices are arranged to be close to the edge of the boundary-layer and they sweep air with high momentum in the stream direction towards the surface of the wing where it partially replaces the retarded air of the boundary-layer which is in turn swept away from the surface. This process occurs continuously and hence the momentum of the boundary-layer air is

increased counteracting the natural tendency of the layer to grow in thickness owing to surface friction and adverse pressure gradients. Thus greater adverse pressure gradients, e.g. stronger shock-waves, can be tolerated before separation occurs. If separation does occur the vortices still promote mixing in the detached layer tending to accelerate reattachment and so restrict the adverse effects associated with such a separation.

The generators were expected to improve the rolling effectiveness in the transonic region by mitigating the shock-induced separation and most of them have done this; in addition three configurations also made an improvement at subsonic and supersonic speeds when in the first instance no shocks exist and in the second, they should have moved back to the trailing-edge region where they cannot cause separations. The "spoiler" effect and the changes in the boundary-layer thickness due to the generators are probably the cause of these effects away from transonic speeds. For ease of comparison the relative merits of the various configurations and of the wing without generators are shown in Fig.13 by means of three histograms, the first showing the transonic effectiveness, the second the effectiveness at supersonic speeds ($M = 1.2$) and the third the subsonic effectiveness ($M = 0.8$). The transonic effectiveness has been taken as the lowest level in the range $0.9 < M < 1.0$. This range covers the dip in the effectiveness curve for the wing without generators.

The relative performance split the configurations into three groups; Nos.1 and 2 showing outstanding improvements. 6 is particularly poor, actually reducing the transonic effectiveness, and the remainder are all good, being two to three times better than without generators. At subsonic and supersonic speeds the pictures are remarkably similar to each other, although slightly different from the transonic results, configurations 1, 2 and 3 show an improvement in effectiveness whereas the others all have, if anything, an adverse influence. Configuration 6 was again the least effective of them all. The significance of these results is discussed more fully in sections 3.1, 3.2 and 3.3. The problem that now arises is to try to fit the variation in performance into a plausible physical framework. This has been tackled by considering the flow fields associated with the generators as postulated by Pearcy in Ref.1 and by comparisons with previous results reported in the same reference.

The vortex arrays produced by the generators are very much dependent on the type of configuration, i.e. co-rotating or counter-rotating, and it is convenient to discuss the configurations tested in groups as follows:-

- (1) the counter-rotating generators: configurations 1, 4, 7, 8, 9,
- (2) the co-rotating generators: configurations 5 and 6,
- (3) the biplane generators of configuration 2 and the tandem row arrangement of configuration 3.

3.1 Counter-rotating generators

With this arrangement the array of vortices produced by the generators does not get transported across the chord in the true stream direction since each vortex is influenced by the pressure of its neighbours and the presence of the wing surface. These influences can be considered as velocities induced at the centre of each vortex which move it in a spanwise direction across the wing and vertically towards or away from the wing. Jones in Ref.4 has derived equations for the motion of a pair of counter-rotating vortices and has shown that the path traced out in the plane normal to the free-stream direction is dependent only on the initial spacings and height above the surface of the generator vanes. These paths are U-shaped and a typical one, corresponding to configuration 1 is shown in Fig.14. The path of neighbouring vortices are the minor images of this path reflected in the lines $\frac{Y}{D} = 0$ and $\frac{Y}{D} = 0.5$. The initial movement of the vortex is downwards

towards the wing surface, then horizontally towards its neighbour from the next pair, and finally very rapidly up and out of the boundary-layer regions. As the vortex and its neighbour come close together they tend to damp one another out as well as moving away from the wing surface and so the effectiveness is maintained only over that part of the path indicated in the figure. Remember that as this U-shaped path is traced out in the plane normal to the stream the vortices are continually being carried chordwise across the wing by the main stream. A typical set of paths of the vortices of a counter-rotating system are illustrated in Fig.15a.

The path of the vortices in the plane parallel to the stream is perhaps more important in these tests since the generators were all situated at $0.5c$ whereas the shock-wave causing separation of the boundary-layer is at about $0.8c$ at the Mach number corresponding to the trough in the effectiveness curve. Thus unless the vortices are still lying close to the wing surface after travelling over $0.3c$ they will not be very effective. Unlike the path in the normal plane which was dependent only on the initial spacing of the vortices, the chordwise path depends on the vortex strength, K . It is difficult to evaluate the vortex strength precisely and hence it is also difficult to determine the path in the chordwise plane, but the effect of vortex strength and initial spacing, D , on the path can be demonstrated qualitatively. The slope of the path in the streamwise plane ($y = 0$) is given in Ref.4 by $\frac{\partial Z}{\partial x} = -\frac{K}{VD} F(Z,Y)$. Thus an increase in strength K , reduces the distance before the vortices leave the surface, and an increase in the initial spacing D increases the range, but of course also means there are less vortices per unit span, which reduces the effectiveness. Since the strength K is not constant, but is dependent on the mutual damping of the vortices, which in turn depends on their spacing, the overall picture is very complicated but these considerations do give a basis on which comparisons of performance can be made.

The vortex strength is initially given by the geometry of the blades and the boundary-layer thickness. The blades in these tests were of constant height, so the area is proportional to the length, but the aspect ratio decreases as the blade length increases therefore the strength will increase with length rather more slowly than linear proportionality.

One fact that emerges from this general discussion is the conflicting influence of vortex strength. If the initial vortex strength is too high the vortex paths will diverge from the wing surface before reaching the separated flow region: if the initial strength is low their paths will remain close to the wing surface but the degree of mixing achieved at the shock may be too small to produce a worthwhile improvement.

If we now look at the transonic effectiveness, shown in the histogram (Fig.13a) it is possible to explain some of the differences in performance, bearing in mind that all five counter-rotating generator configurations substantially improved the effectiveness.

On this basis it becomes clear that configuration 8 which had very closely spaced vanes, $\frac{D}{h} = 2.5$ would have a very short range of effectiveness and that its vortices would move out of the boundary-layer, before they reached the shock-wave position. It also had a low initial vortex strength which would be reduced by viscous damping considerably because of the close spacing. This all confirms the relatively poor performance of this configuration.

Configurations 4 and 9 had the same blade spacing, $\frac{D}{h} = 16$, but 9 had somewhat weaker vortices, therefore it would be expected to have a rather

longer range of effectiveness so that its vortices would be lower in the boundary-layer at the shock position of the transonic trough and hence more effective in reducing the effects of the separation. This result is confirmed in Fig.13a. Although a large value of $\frac{D}{h}$ implies a long range of effectiveness, the overall amount of vorticity will be rather low since there will be so few vanes across the wing span. Each pair of vortices may well be effective over a local part of the span, but the wide spacing may leave large areas of the wing unaffected by vortices and they therefore show up unfavourably compared to configuration 1.

Configuration 1 has the same strength as configuration 9 but a reduced $\frac{D}{h}$ which would give a rather shorter range of effectiveness but apparently still long enough to reach the shock position and the increased number of vortices gives a good coverage across the wing. The vortex strength seems adequate to give good effectiveness and the overall result was excellent as it had also been found to be in small-scale tests at N.P.L.¹

Configuration 7 was similar in performance to configuration 4 and 9 although its initial spacing was like that of configuration 1. It had smaller blades giving vortices of lower strength which should increase the range of effectiveness, but it was shown above that the range was adequate for $\frac{D}{h} = 10$ as the additional range from lower vortex strength does not help further, rather the opposite, since the vortex strength being lower is reflected in a reduced effectiveness. This may be aggravated by the closeness of the vanes of each pair ($\frac{D}{d} = 8.3$, (see Table 1)) which may cause a high initial damping until they move a little farther apart. It might be concluded that configuration 1 was the best as it was a happy medium with regard to spacing and vortex strength since too great or too little of either produces adverse effects.

At subsonic and supersonic speeds (Figs.13b and c) only configuration 1 improved the effectiveness, and although the increments in $\frac{F_b}{2V\xi}$ were similar to those transonically the percentage changes were very much smaller, being within $\pm 15\%$, compared to several hundred per cent before. The changes must be accounted for by change in the pressure distribution resulting from changed boundary-layer thickness and from reduced static pressure between the vortices behind the generators. There will be an opposing positive pressure increment in front of the blades, but for configuration 1, the nett result was a gain in rolling effectiveness. The subsonic improvement is easier to understand since conditions at the trailing edge and hence on the under surface of the wing, can be affected by the presence of the generators. No work at N.P.L. was done at true supersonic speeds so no information for comparison is available.

3.2 Co-rotating generators

The induced velocities of a co-rotating system produce a much simpler motion of the individual vortices. Theoretically there is no motion induced in the vertical direction so the vortices remain at their initial height as they traverse the wind chord. There are lateral velocities induced which make each vortex travel on a curved path across the chord. All the vortices travel on parallel paths and thus they remain at the same spacing as the generator blades. A typical set of vortex paths for a co-rotating system is illustrated in Fig.15b. Without the complexity of path associated with the counter-rotating types it is found that the most important factor in the effectiveness of co-rotating generators is the spacing of the vanes. If the vanes are too close together there will be damping and interference

effects, and at the other extreme, if the blades are too widely spaced the vortex strength per unit span will be low and so also will their effectiveness. Earlier work² has shown that a spacing of $\frac{D}{h} = 3$ is a minimum for the establishment of a favourable vortex pattern. The optimum spacing may be slightly larger than $\frac{D}{h} = 4$, but anything less than $\frac{D}{h} = 3$ would not be expected to produce a satisfactory pattern. The orderly array of vortices behind co-rotating generators is not maintained at the extremities of the generator row where the end vortex has no neighbour on one side to continue the balancing out of induced velocities. This causes the end vortex to move away from the surface and spiral round the path of its neighbour with a resulting loss of efficiency.

The two configurations with co-rotating systems numbers 5 and 6 which were tested bore out previous results. Configuration 5, which had a blade spacing of $\frac{D}{h} = 5$, a little larger than the optimum, was reasonably successful at transonic speeds although it was not as good as configuration 1. This result reproduces remarkably well the comparison between the same two configurations in Ref.1, Fig.103. It is interesting to note here that when tested on a smooth aerofoil, i.e. without a deflected flap, the co-rotating generators show up much better being almost as good as configuration 1 (Ref.1, Fig.102).

Configuration 6, with very closely spaced blades, $\frac{D}{h} = 1.2$ was expected to show little or no improvement and in fact it reduced the rolling effectiveness throughout the Mach number range. The close spacing produces adverse effects similar to those of closely spaced counter-rotating generators - high viscous damping and mutual interference - so that low energy air swept out of the boundary-layer by one vortex tends to be swept in again by the adjacent ones.

At supersonic speeds both configurations caused reductions in effectiveness consistent with their blockage effect. In fact for all configurations causing a reduction in supersonic effectiveness, the reduction could be correlated to the physical magnitude of their blockage effect, taken as the projected area of the blades normal to the stream direction.

3.3 Biplane generators and tandem row generators

Biplane generators, the only example of which was configuration 2, consist of a combination of two counter-rotating systems one being of divergent pairs of vanes as usual, and the second set being convergent pairs of vanes. These component rows are referred to as the d_1 and d_2 system respectively. The paths of the vortices and hence the effectiveness of this arrangement can be considered in terms of the induced velocities of one system on the other. The induced velocities cause the vortices of the d_1 system to move down towards the surface and those of the d_2 system to move away from the surface. The d_1 system behaves just like a counter-rotating system underneath the d_2 system. Such an arrangement gives very good mixing in the boundary-layer as the d_1 vortices are kept lower in the layer and the low energy air swept up by these vortices is removed further into the stream by those of the d_2 system. Configuration 2, whose d_1 system alone would have been reasonably effective, proved to be one of the most successful tested, both at transonic speeds and supersonic speeds. This is result of the favourable vortex paths and possibly also because of the location of

the blades at 0.65c rather than at 0.5c, which is much closer to the shock position at the trough of the effectiveness curve (0.75c - 0.8c). This position for the generators was chosen because the biplane system was expected to have only a short chordwise range of effectiveness, as a result of increased damping losses owing to the second set of vortices.

The idea behind tandem row generators is to recreate vorticity at a suitable distance downstream of the first row when the set of vortices from the forward row have lost their effectiveness by being damped out or having moved away from the boundary-layer. The second row of generators in configuration 3 consisted of wing-type generators mounted at incidence on a central blade forming a T-section arrangement. The front row of generators of configuration 3 was identical with configuration 4 and their transonic effectiveness are very similar, the tandem row one being slightly better. At supersonic speeds the shock has moved well aft of the second row of generators onto the trailing edge and the tandem row is then very much more effective than configuration 4. In N.P.L. tests of this configuration its effectiveness was as good as that of configuration 1, which is true of the present tests at the higher speeds but not transonically. However, the earlier tests were not done on a wing with deflected flap and this has previously been seen to make a difference (see section 3.2). The present results tend to confirm the theoretical conclusion that the counter-rotating vortices of the forward row lose their effectiveness by moving out of the boundary-layer after travelling a short distance downstream and that the improvements in configuration 3 over 4 are due to vorticity being re-created where that from the forward row has become ineffective.

4. COMPARISON BETWEEN THE FREE-FLIGHT RESULTS AND PREVIOUS RESULTS DESCRIBED IN REF.1

Some of the configurations tested were identical with those previously tested and reported in Ref.1. The remainder are closely related to earlier configurations and comparisons can be drawn for all configurations, between the measured effectiveness in free-flight and that measured in previous experiments. (All page numbers, Fig. numbers and Table numbers quoted in this section refer to Ref.1.)

Configuration 1

This was the same as N.P.L. configuration M.2, which was selected, P.1296, as the most consistently successful design for a combination of reasonable level of effectiveness and a large range of effectiveness. This is shown in Figs.102 and 103 and is well borne out by the R.A.E. tests which also showed it to be one of the best tested.

Configuration 2

Apart from a slight difference in blade length this was like N.P.L. configuration B.3 which has been shown (Fig.103) to be slightly better than M.2. This is consistent with the present results but some of the effectiveness of No.2 may be accounted for by it being set on the wing at 0.65c, which is rather nearer the offending interaction which is thought to be between 0.75c and 0.8c at the Mach number corresponding to the dip in the transonic effectiveness curve.

Configuration 3

This was the N.P.L. configuration T.1, a tandem row set of generators, which previously (Fig.102) was almost as good as N.P.L. M.2 (R.A.E. No.1). The present tests confirm this at subsonic and supersonic speeds but configuration 3 was not so good at transonic speeds. The previous tests

were, however, made on a plain wing without deflected flap and this may be the cause of the difference, since a similar difference between flapped and plain wings showed up for co-rotating generators (Figs.102 and 103).

Configuration 4

This is configuration 3 without the second row of generators and has also been tested at N.P.L., though the results are not given in Ref.1. It was a little inferior to the tandem row at transonic speeds which is in agreement with the N.P.L. results. The stronger vortices of this configuration over those of No.1 reduce the chordwise range of effectiveness and, together with the rather reduced number of vortices leaving areas of the wing unaffected, accounts for the rather inferior performance.

Configuration 5

There was no exact N.P.L. equivalent but it is similar to C_1 and C_4 , with which the present results agree remarkably well. C_1 and C_4 were not so good as M.2 on a deflected flap but were as good on a plain aerofoil.

Configuration 6

Although a similar configuration has not been tested, experimental work reported in Ref.1 has shown that the blade spacing is well below the minimum for establishing a satisfactory vortex pattern. The reduced effectiveness throughout the Mach number range was to be expected and this configuration has confirmed previous evidence on too closely spaced generators.

Configurations 7, 8 and 9

No similar configurations have been tested previously but their performances can be understood by considering the vortex paths.

Configuration 7 has rather weak vortices initially and they may be further reduced in strength by high viscous dissipation at first; their subsequent paths should be favourable but their low strength can only give average effectiveness.

Configuration 8 has very closely spaced pairs of vanes which results in the vortices leaving the surface of the wing before they have been carried far across the chord and this gives a low effectiveness.

Configuration 9, like No.4, has rather too few vortices, and despite the expected good performance of them, probably leaves areas of the wing unaffected by the vortex mixing and gives only a moderate performance.

5 CONCLUSIONS

Nine vortex-generator configurations have been tested in free-flight. The improvement in rolling effectiveness of a flap control on an unswept wing fitted with generators over that of a similar wing without generators has been taken as a measure of the efficiency of the configurations in alleviating the effects of shock-induced boundary-layer separation.

All but one of the configurations produced some improvement in transonic control effectiveness, the best of them almost completely eliminating the loss in effectiveness caused by the separation. Three of the configurations also improved control effectiveness at subsonic and supersonic speeds.

An analysis of the paths traced out by the vortices provides some insight into the relative merits of the various configurations. Unfortunately these comparisons are not completely valid because the theory describing the paths does not wholly account for the effect of vortex strength and path shape and hence fails to indicate the influence of vortex height at the shock position downstream of the generators.

A comparison of the present results with earlier tunnel tests made by N.P.L.¹ has been made and good qualitative agreement between them exists.

LIST OF SYMBOLS

- b = diameter of the circle which circumscribes the three wing tips - ft
- c = wing chord
- d = distance between vanes of co-rotating generators, or between vanes of a pair of counter-rotating generators
- $\left. \begin{matrix} d_1 \\ d_2 \end{matrix} \right\}$ = distances defining the biplane generators as shown in Table 1
- D = distance between pairs of vanes of counter-rotating generators
- h = vane height
- K = vortex strength
- l = vane length
- M = Mach number
- P = rate of roll - degrees/sec
- V = free-stream velocity - ft/sec
- X = chordwise co-ordinate
- Y = spanwise co-ordinate
- Z = vertical co-ordinate
- $\left. \begin{matrix} X \\ Y \\ Z \end{matrix} \right\}$ with origin at the mid-point between the vanes of a pair of counter-rotating generators on the wing surface
- α = incidence of vane to free-stream direction - degrees
- ξ = control deflection - degrees

LIST OF REFERENCES

- | <u>No.</u> | <u>Author</u> | <u>Title, etc.</u> |
|------------|--|--|
| 1 | Pearcey, H.H. | Shock-induced separation and its prevention by design and boundary-layer control. Boundary-layer and flow control. Ed. G.V. Lochmann. Pergamon Press. 1961. |
| 2 | Tanner, L.H.
Pearcey, H.H.
Tracy, C.M. | Vortex generators, their design and their effects on turbulent boundary-layers. A.R.C. 16.487. January, 1954. |
| 3 | Lawrence, T.F.C.
Swan, J. | Development of a transonic research technique using ground-launched rocket-boosted models. Part 1. Control effectiveness measurements. A.R.C. 13,740. July, 1950 |
| 4 | Jones, J.P. | The calculations of the paths of vortices from a system of vortex generators, and a comparison with experiment. A.R.C. C.P. 361. March , 1955. |
| 5 | Pearcey, H.H.
Pankhurst, R.C.
Cash, R.F. | High speed tunnel tests on a 10% thick R.A.E. 102 two-dimensional aerofoil with 25% flap: Results at zero-incidence with 4° flap deflection. A.R.C. 15,176. September, 1952. |
| 6 | De Young, J. | Theoretical antisymmetrical span loading for wings of arbitrary planform at subsonic speeds. N.A.C.A. Report No. 1056. 1951. |
-

TABLE I.
VORTEX-GENERATOR CONFIGURATIONS.
CHORD = 9 INCHES $h = 0.01 \times \text{CHORD}$

No.	CONFIGURATION	α DEG	$\frac{D}{h}$	$\frac{D}{d}$	$\frac{l}{h}$	CHORD- WISE POSITION
1	<p style="text-align: center;">DIRECTION OF FLOW.</p>	15	10	4	2.5	0.5c
2		15	5	$\frac{D}{d_1} = 4$ $\frac{D}{d_2} = 1.25$	1.25	0.65c
3	<p style="text-align: center;">END VIEW</p>	15	16	4	4	0.5c 0.65c
4		15	16	4	4	0.5c

TABLE I. (CONT'D.)
VORTEX-GENERATOR CONFIGURATIONS.
 CHORD = 9 INCHES $h = 0.01 \times \text{CHORD}$.

No.	CONFIGURATION .	α DEG	$\frac{D}{h}$	$\frac{D}{d}$	$\frac{l}{h}$	CHORD -WISE POSITION
5	<p style="text-align: center;">DIRECTION OF FLOW ↓</p>	20	5	-	4	0.5c
6		20	1.2	-	1.25	0.5c
7		15	10	8.3	1.25	0.5c
8		15	2.3	2.1	1.25	0.5c
9		15	16	6.4	2.5	0.5c

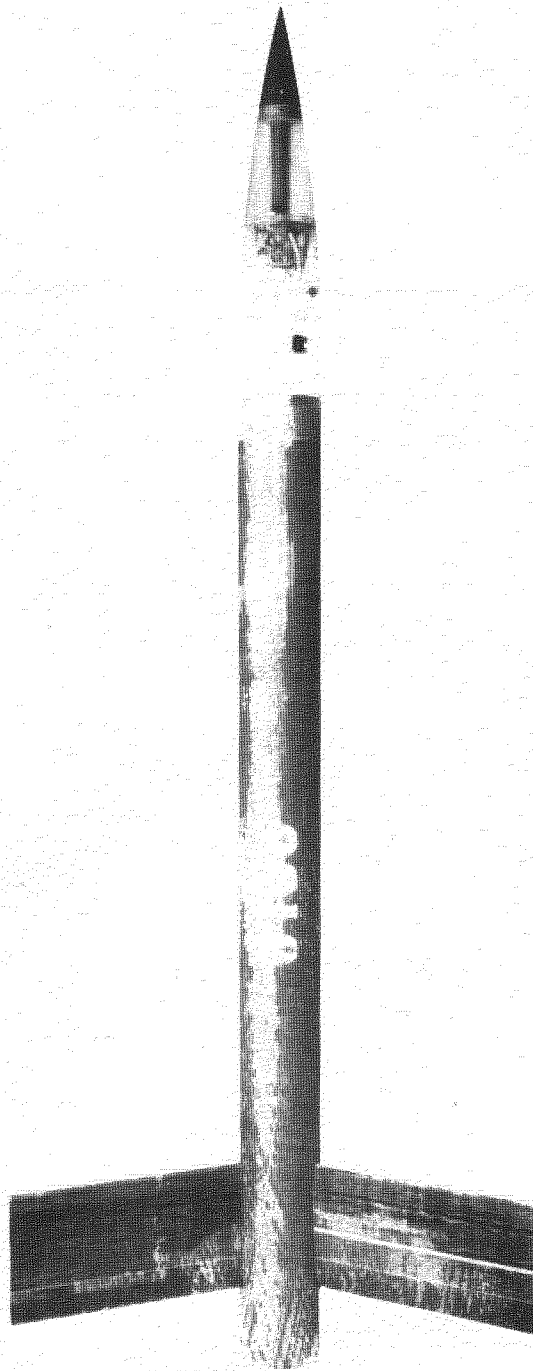

FIG.1. TYPICAL ROLLING-EFFECTIVENESS MODEL

ALL DIMENSIONS IN INCHES.

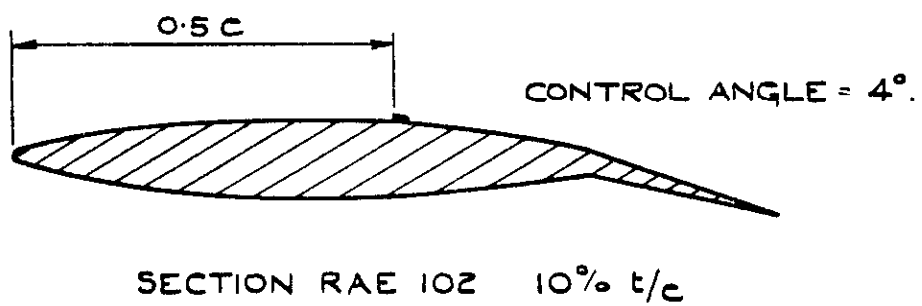
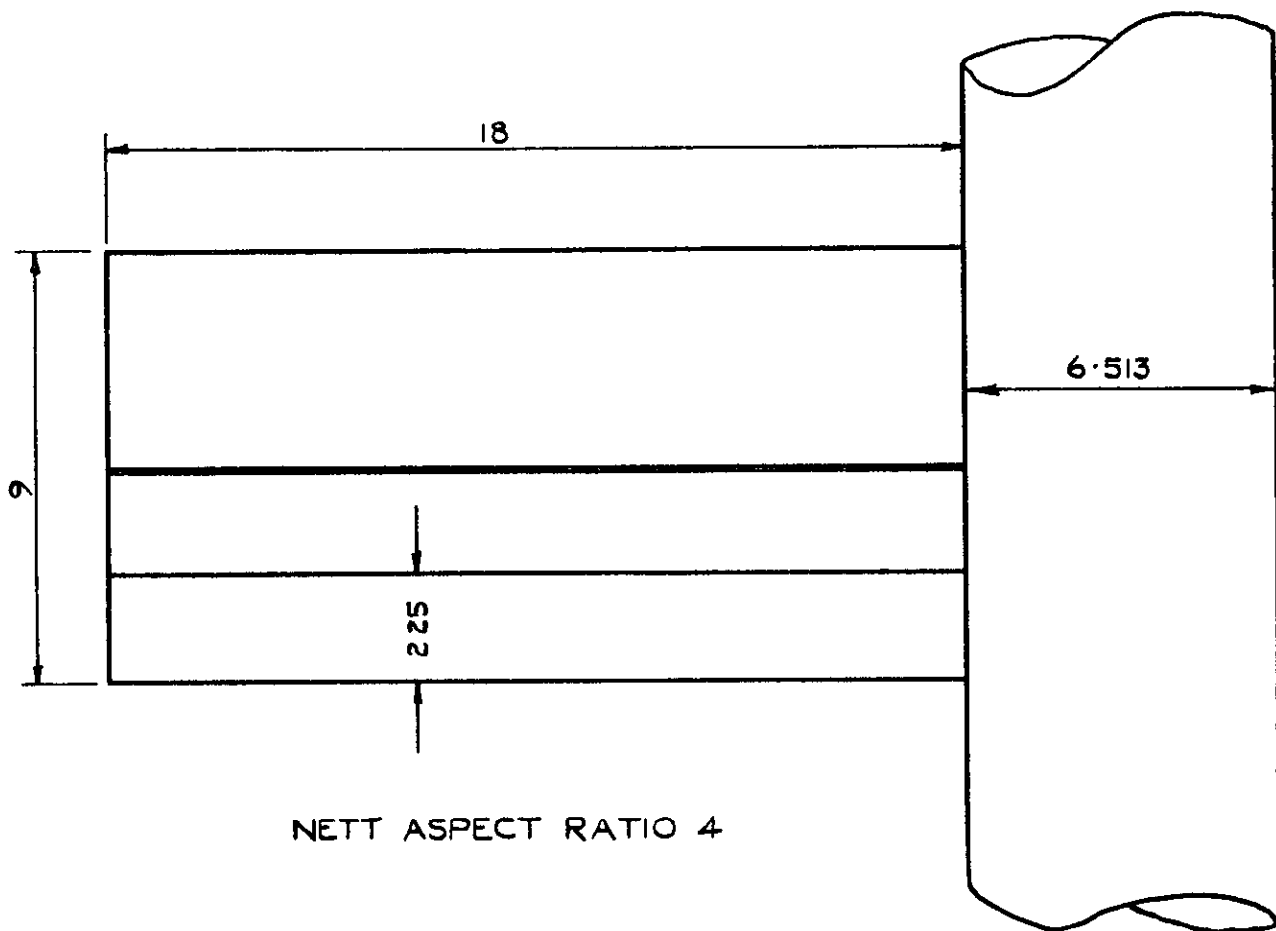
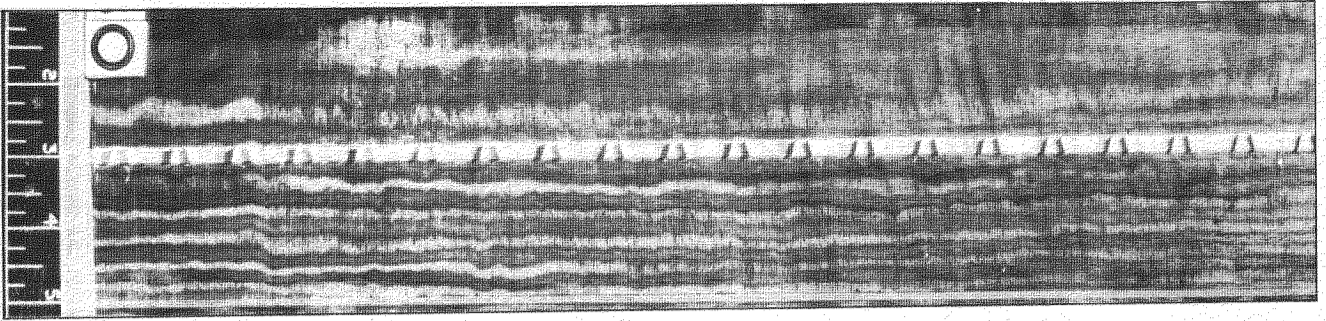
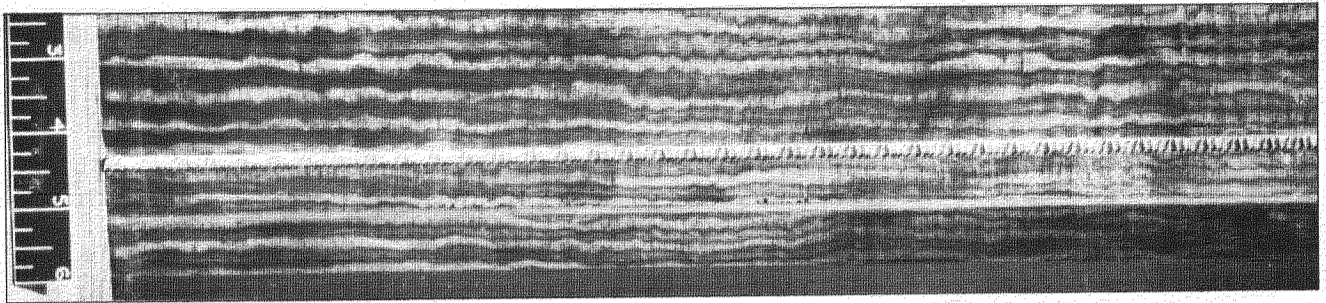

FIG. 2. WING DETAILS.



CONFIGURATION 1



CONFIGURATION 2

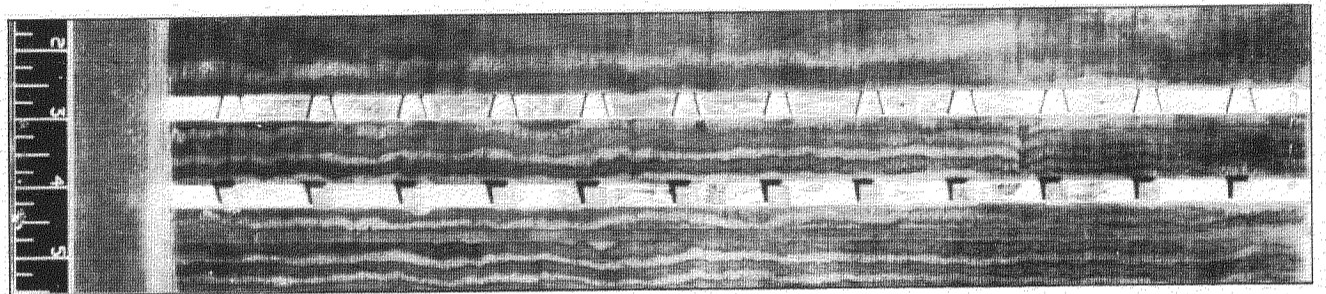

CONFIGURATION 3

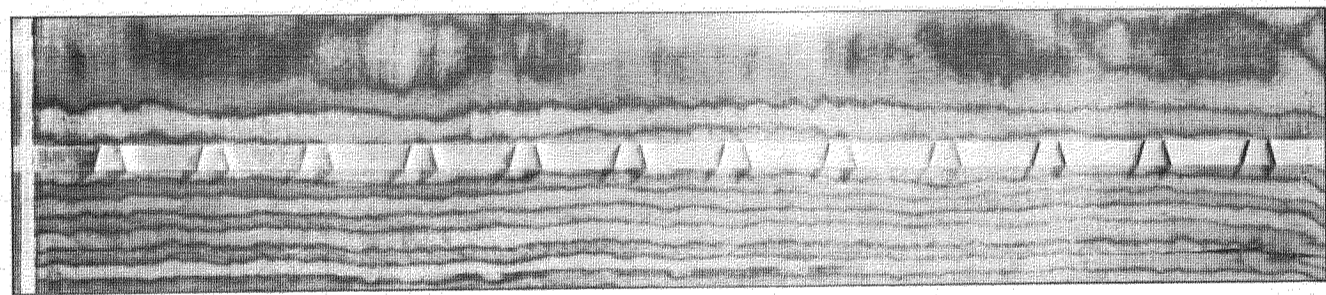

CONFIGURATION 4

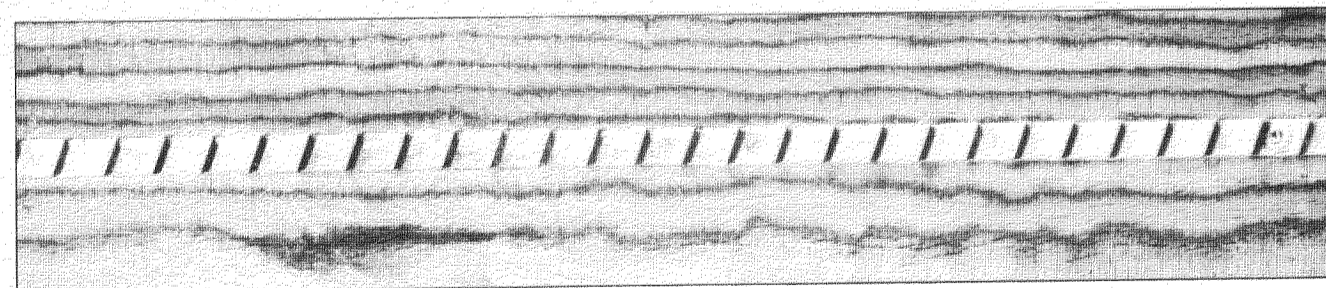

CONFIGURATION 5

FIG.3. VORTEX-GENERATOR CONFIGURATIONS

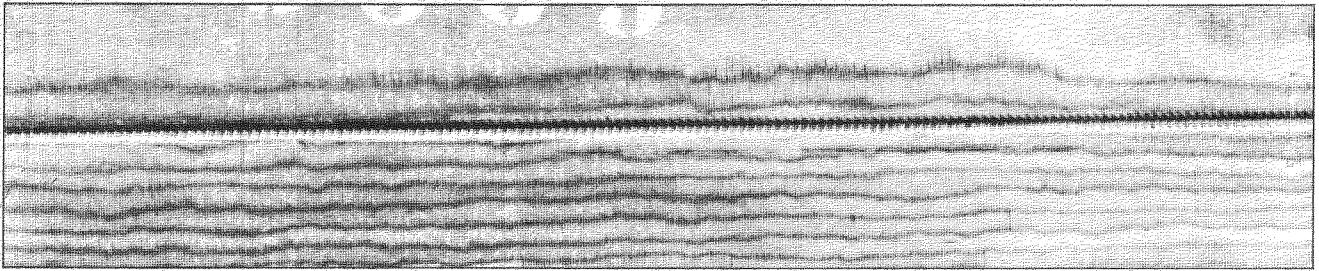

CONFIGURATION 6

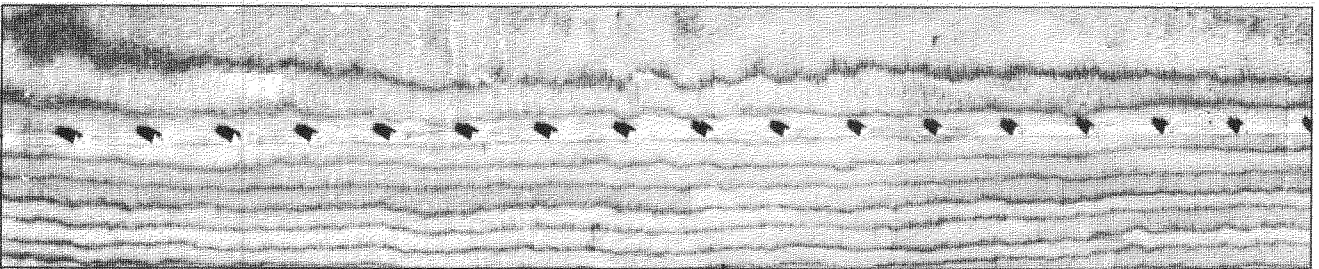

CONFIGURATION 7

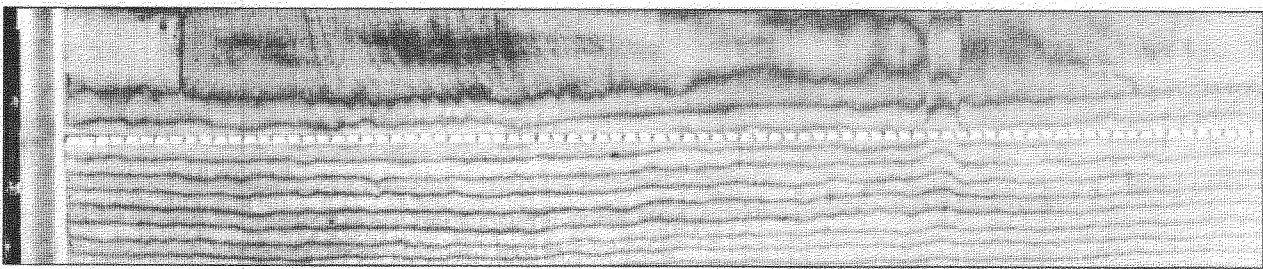

CONFIGURATION 8

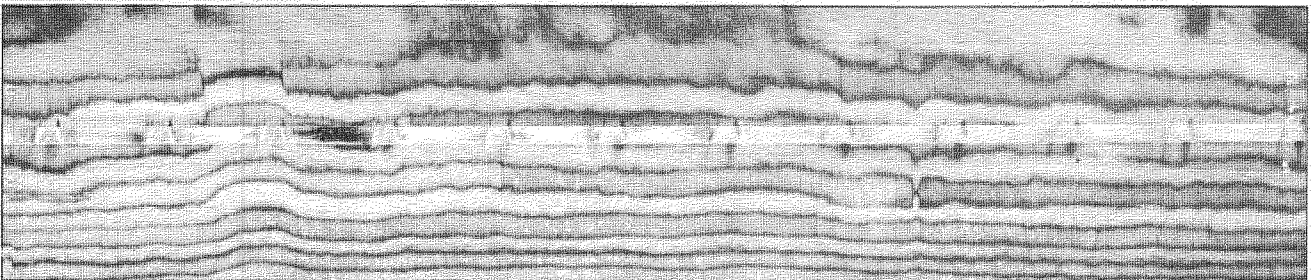

CONFIGURATION 9

FIG.3. cont'd VORTEX-GENERATOR CONFIGURATIONS

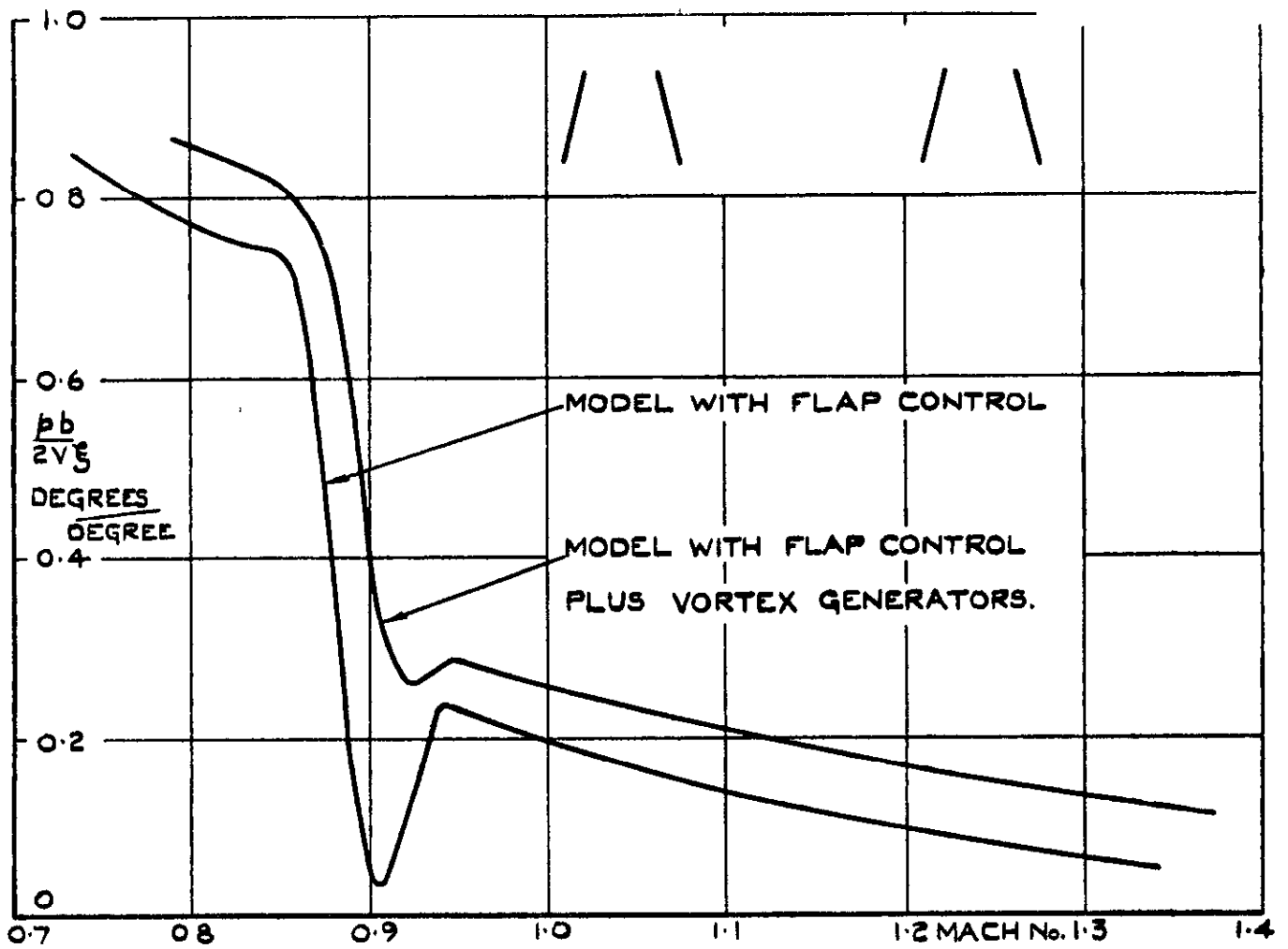

FIG. 4. ROLLING EFFECTIVENESS OF CONFIGURATION 1.

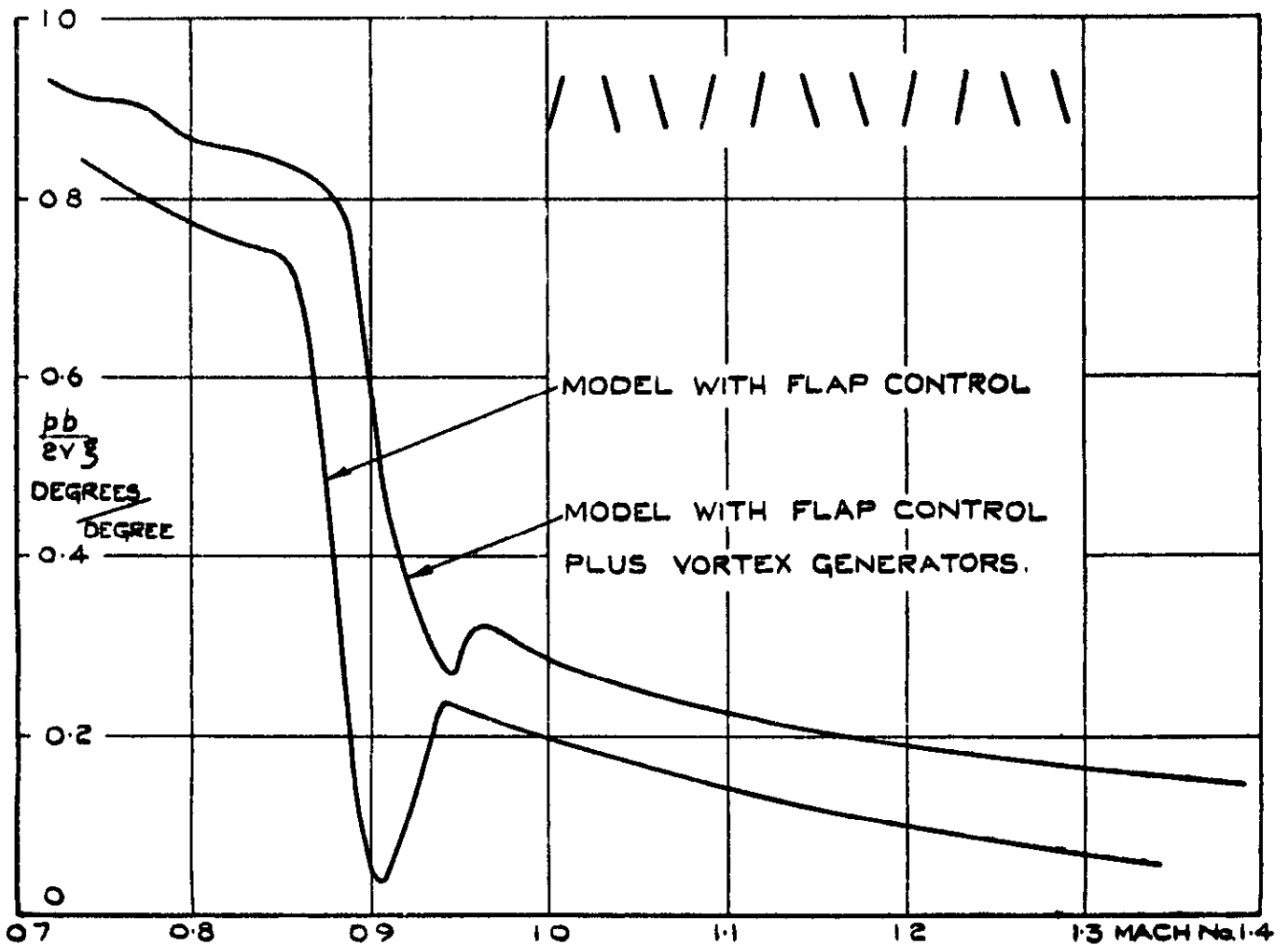

FIG. 5. ROLLING EFFECTIVENESS OF CONFIGURATION 2.

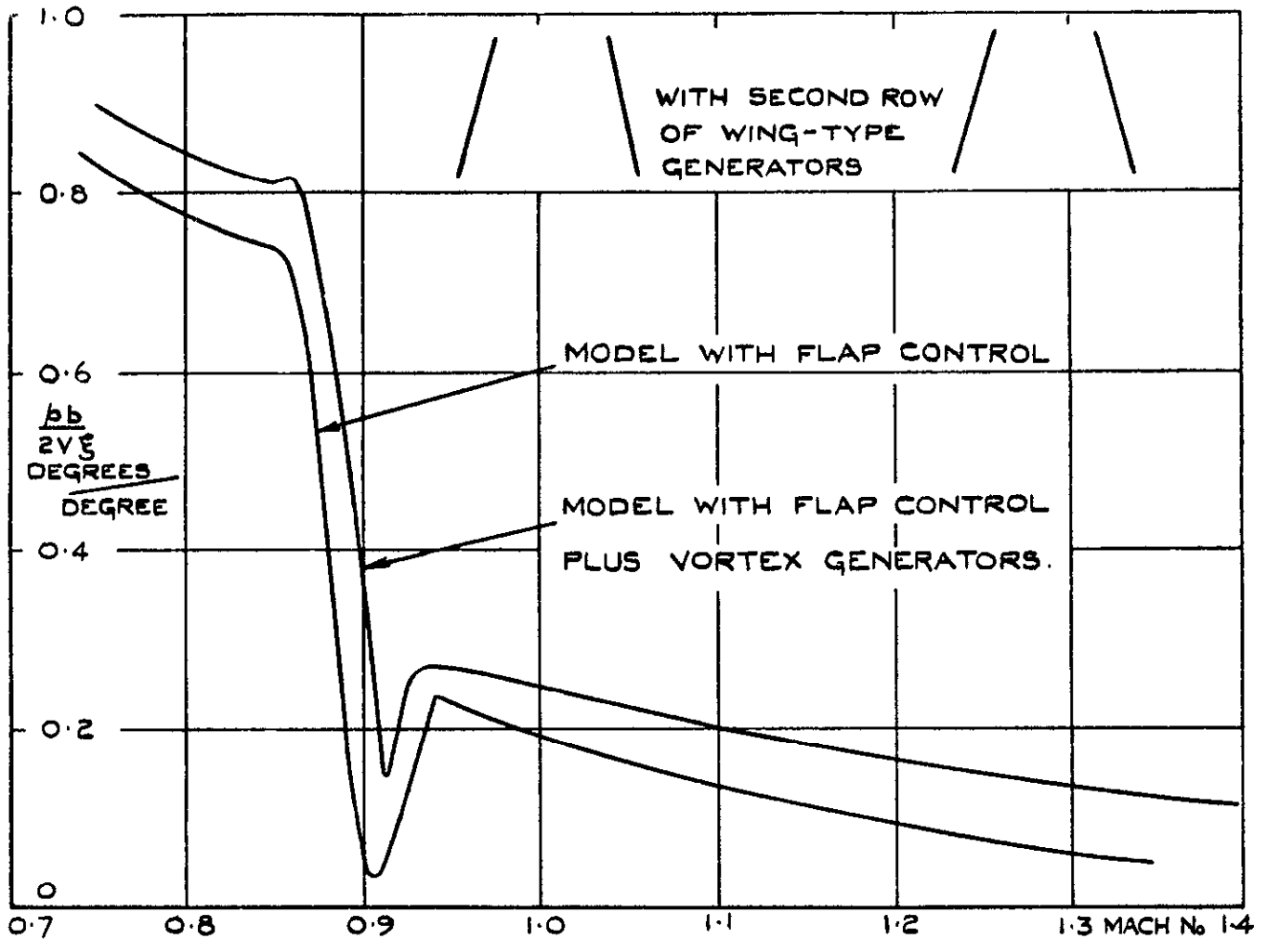

FIG. 6. ROLLING EFFECTIVENESS OF CONFIGURATION 3.

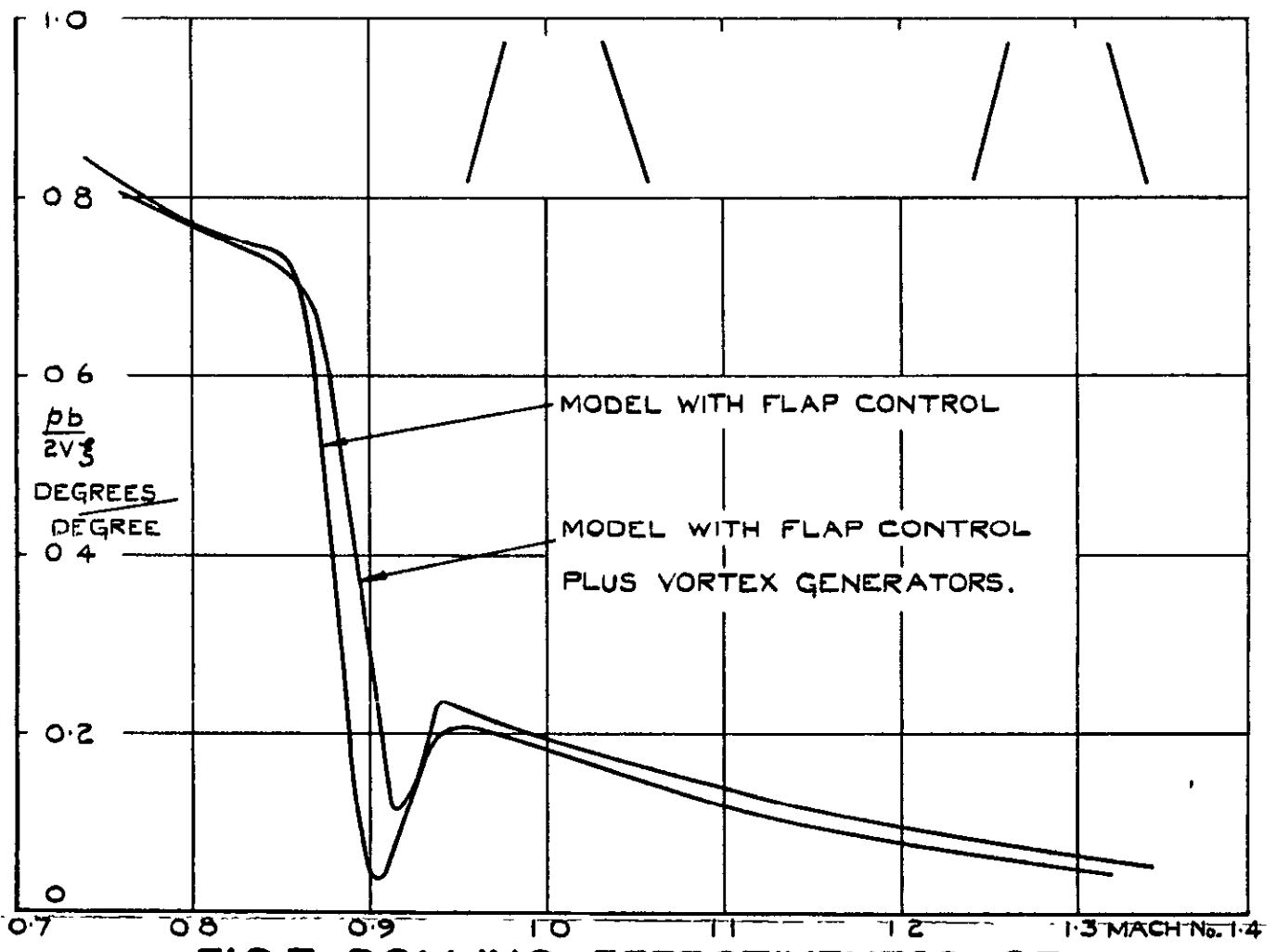

FIG. 7. ROLLING EFFECTIVENESS OF CONFIGURATION 4.

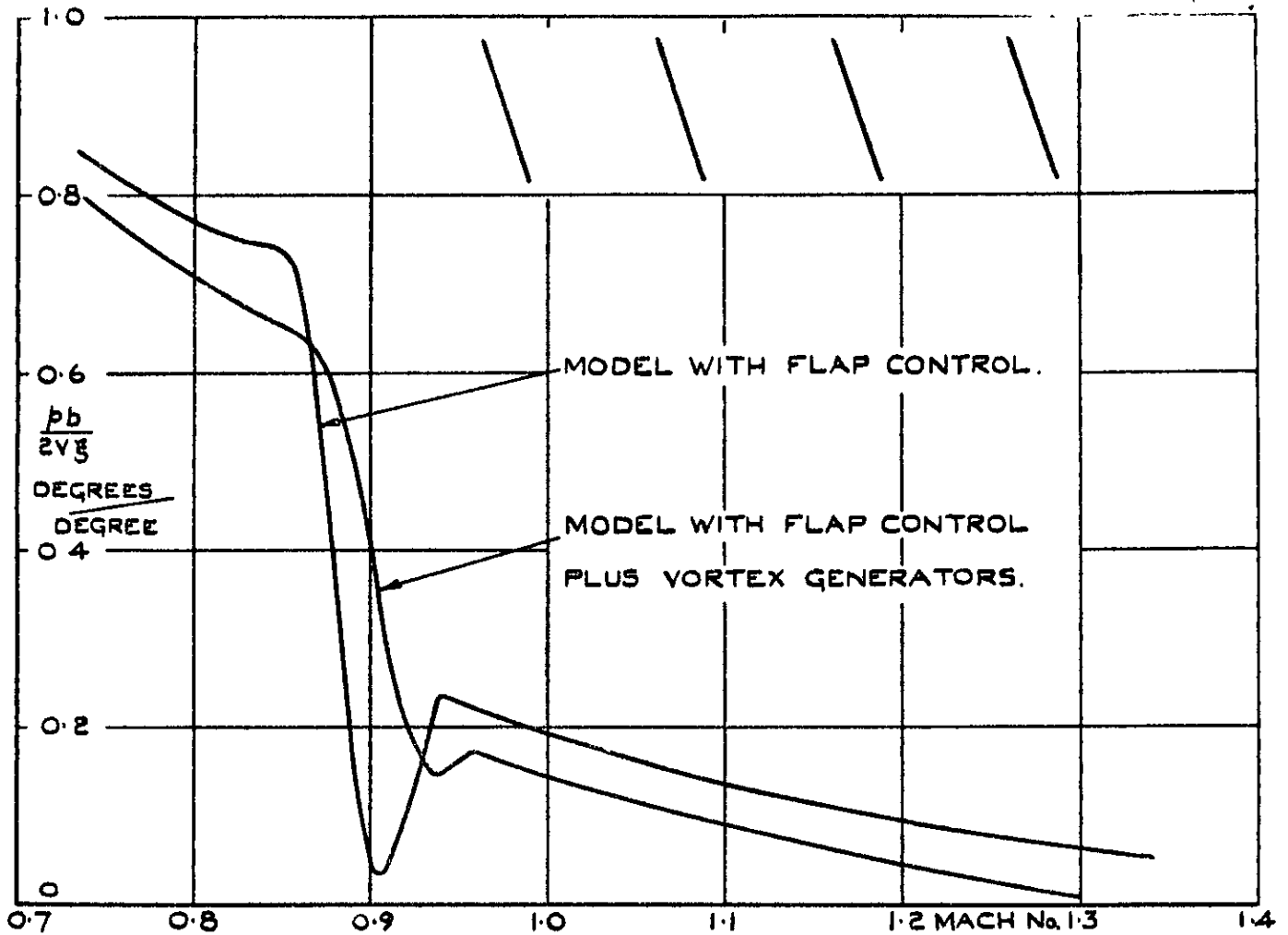

FIG. 8. ROLLING EFFECTIVENESS OF CONFIGURATION 5.

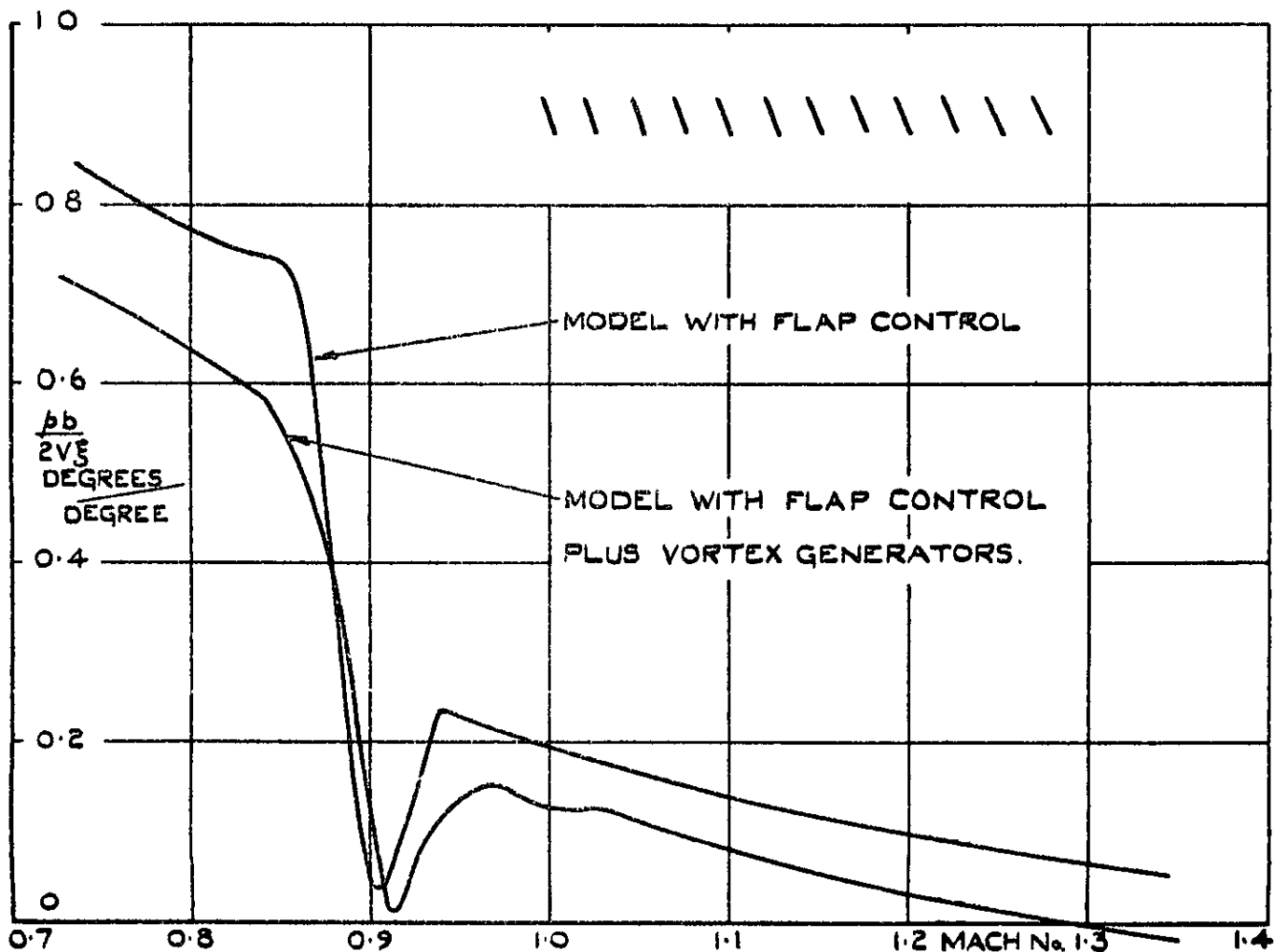

FIG. 9. ROLLING EFFECTIVENESS OF CONFIGURATION 6.

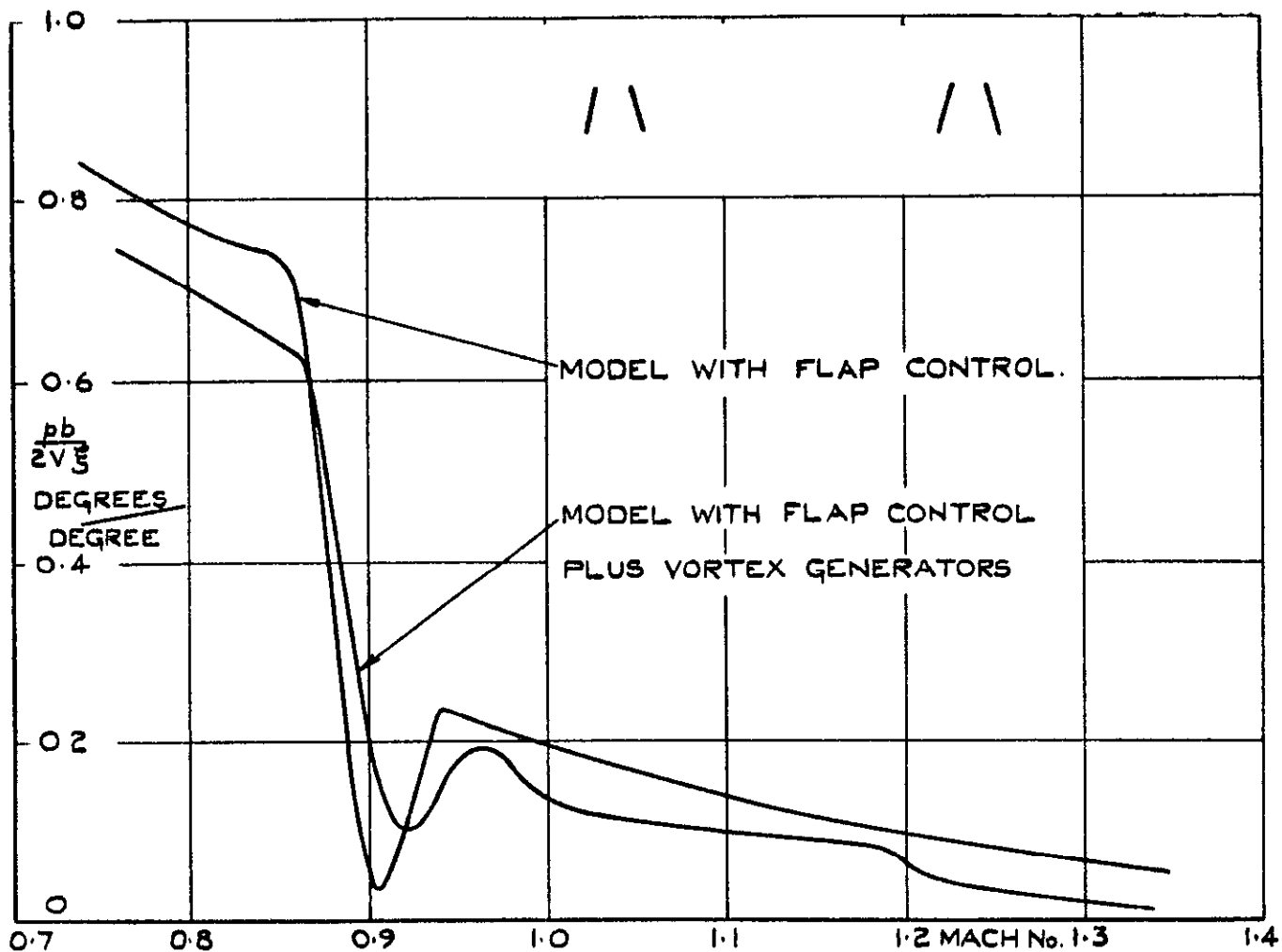

FIG. 10. ROLLING EFFECTIVENESS OF CONFIGURATION 7.

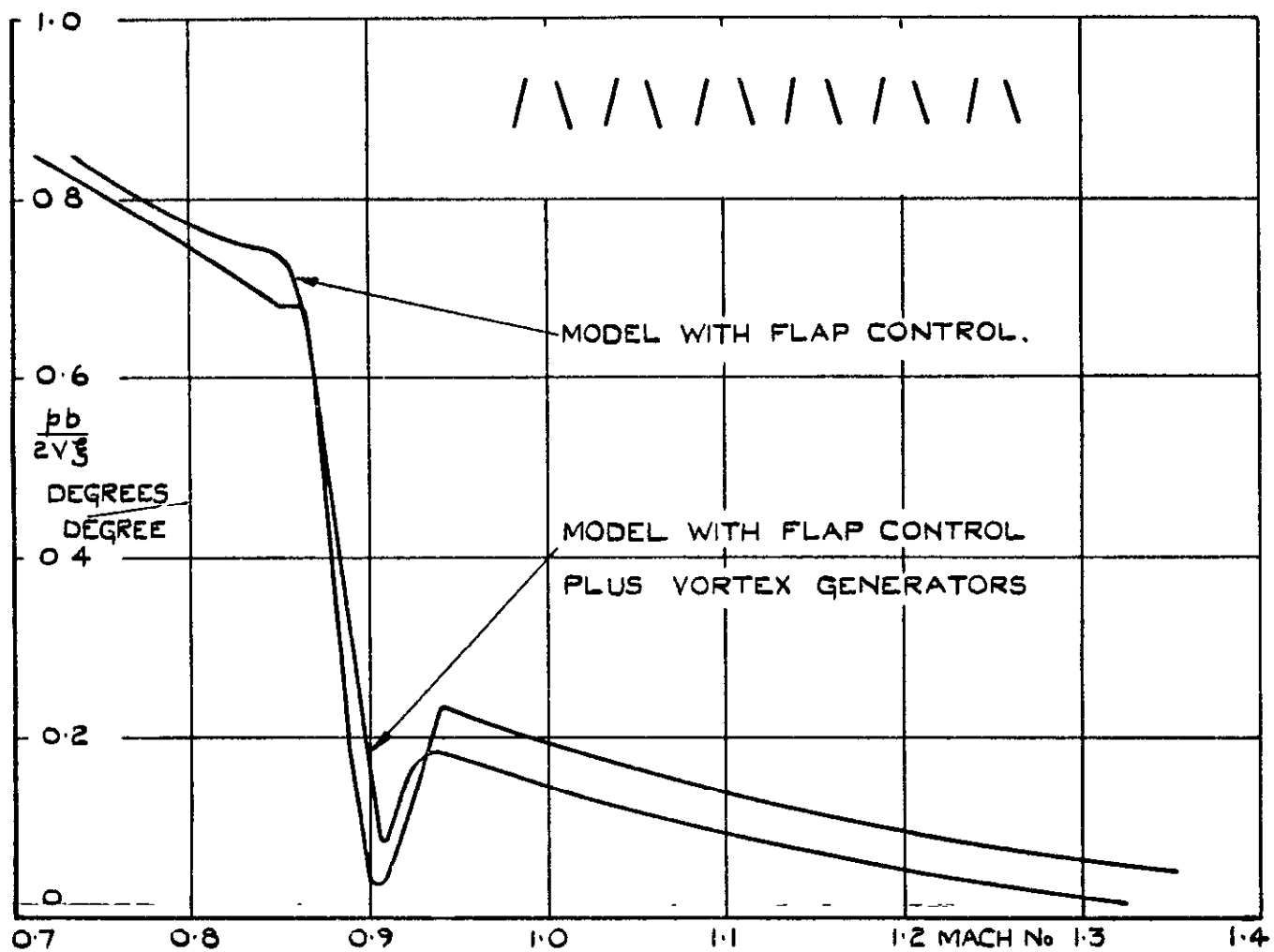

FIG. 11. ROLLING EFFECTIVENESS OF CONFIGURATION 8.

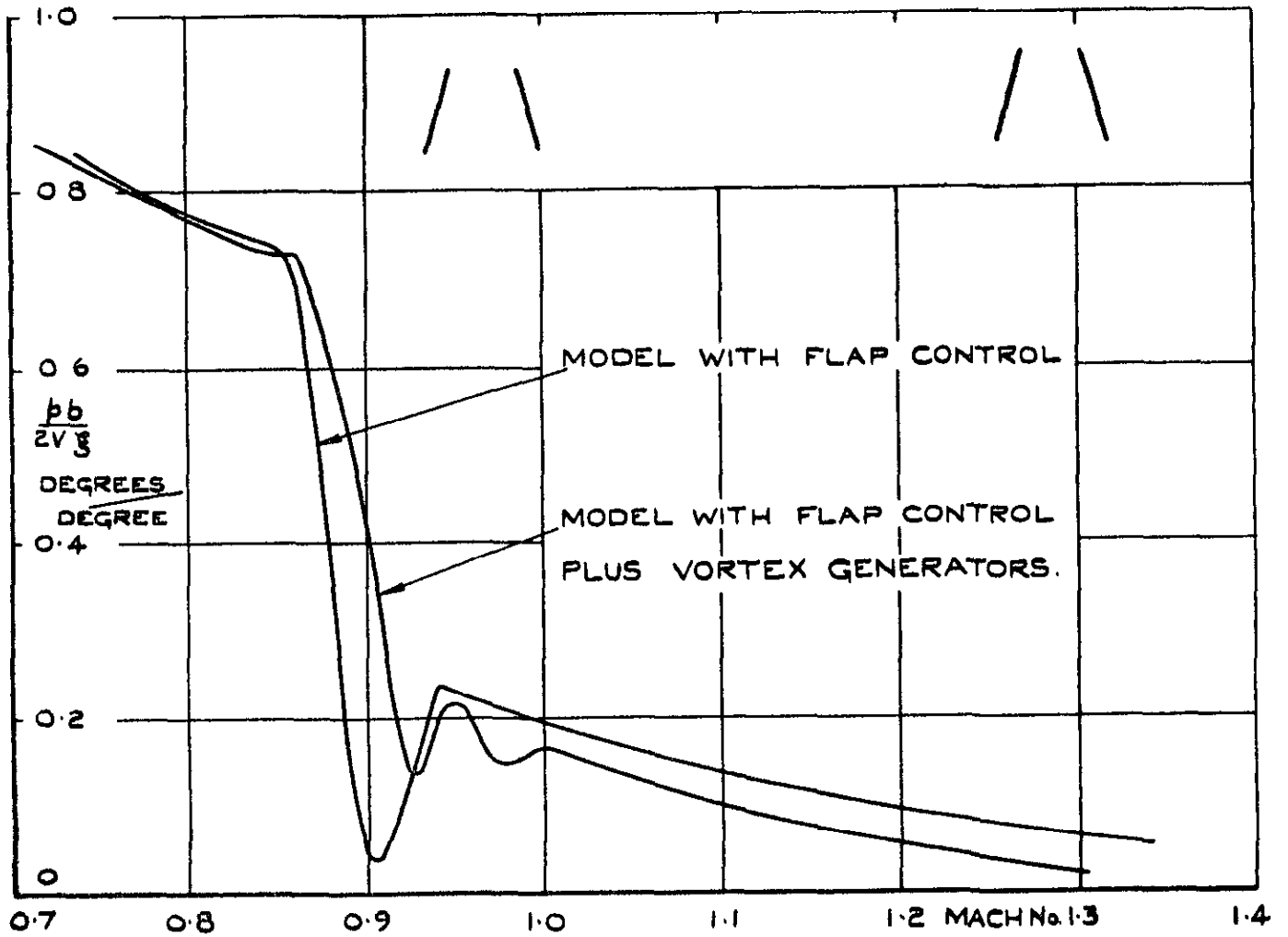
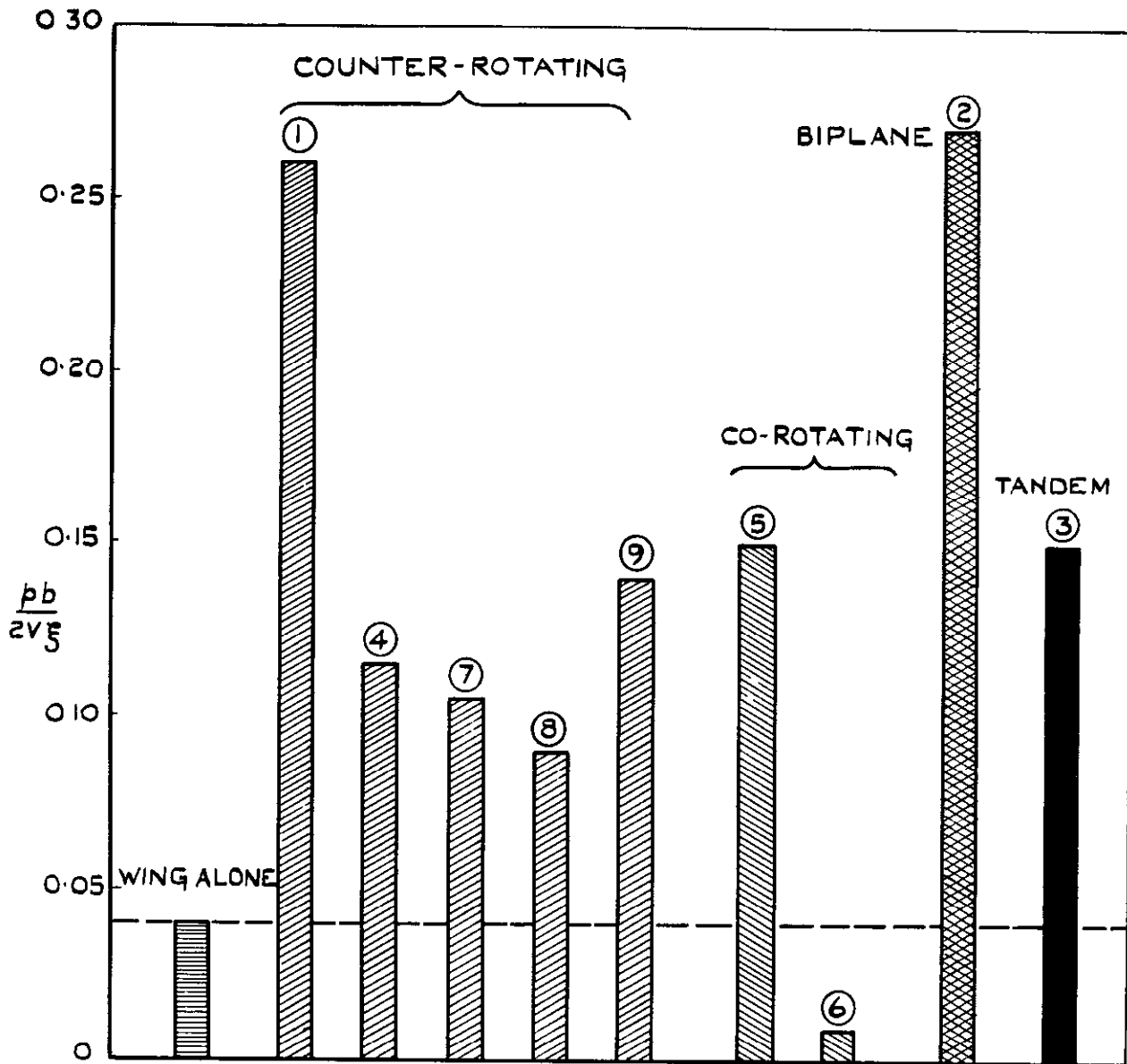
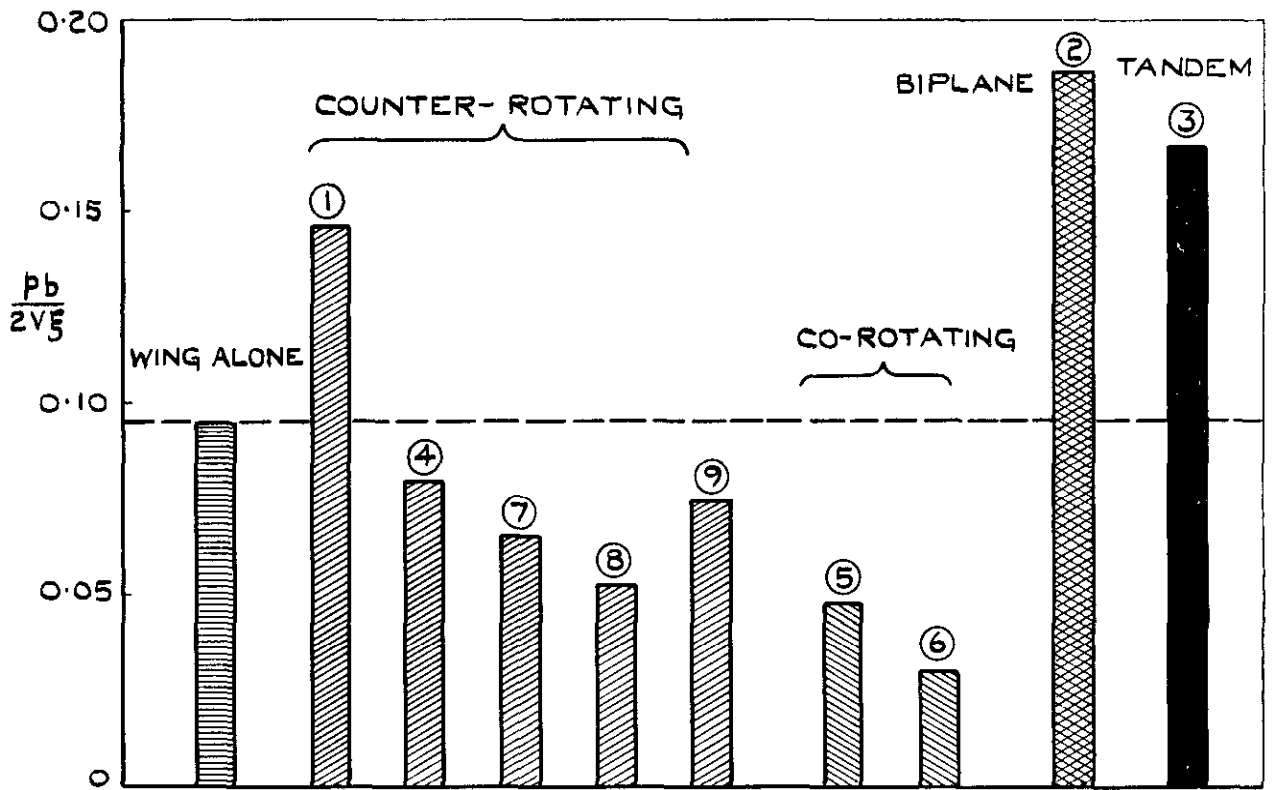

FIG.12. ROLLING EFFECTIVENESS OF CONFIGURATION 9.



(G) LOWEST LEVEL OF EFFECTIVENESS IN RANGE $0.9 < M < 1.0$.

FIG. 13.(a) HISTOGRAM FOR COMPARISON OF EFFECTIVENESS.



(b) EFFECTIVENESS AT $M=1.2$.

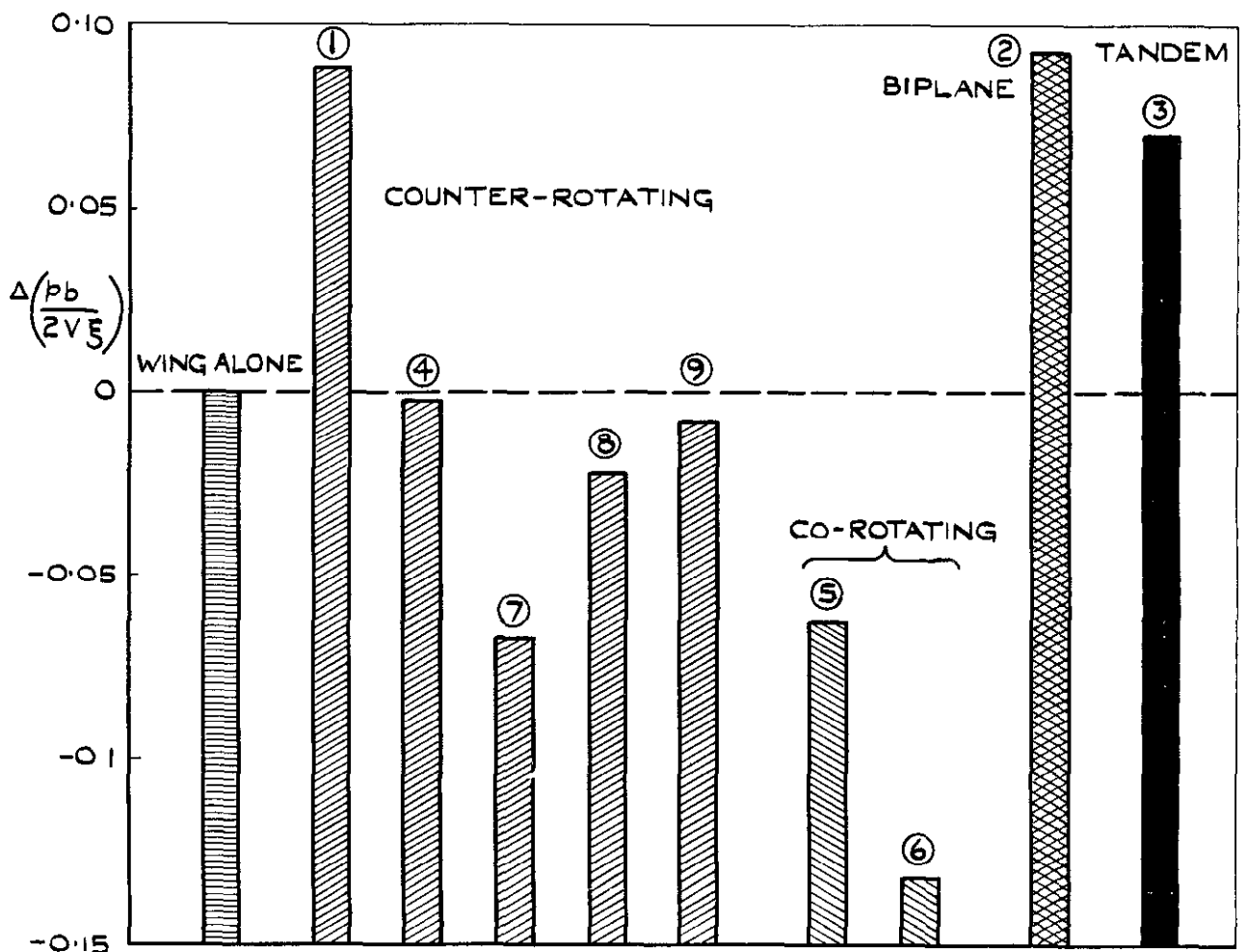

(c) EFFECTIVENESS AT $M=0.8$.

FIG.13.(b-c) HISTOGRAM FOR COMPARISON OF EFFECTIVENESS.

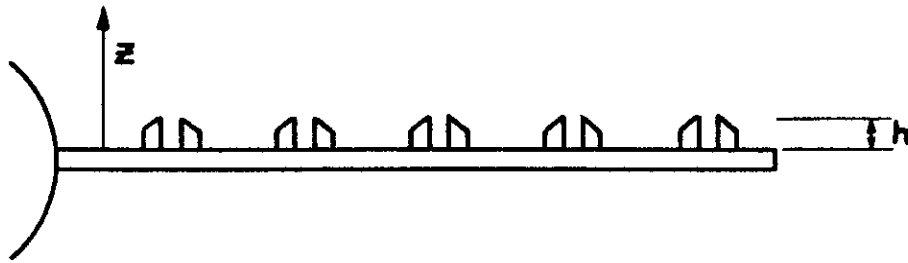

NOT TO SCALE.

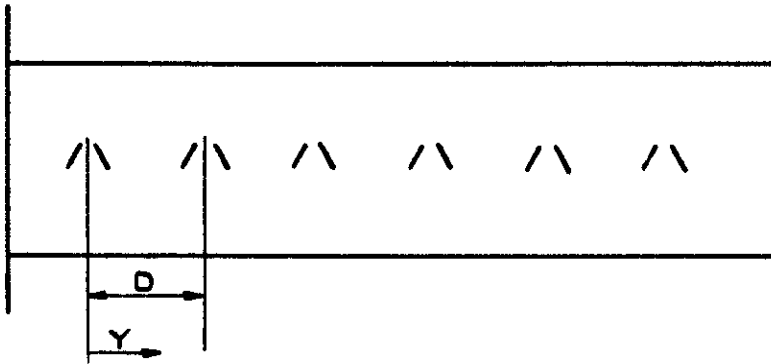
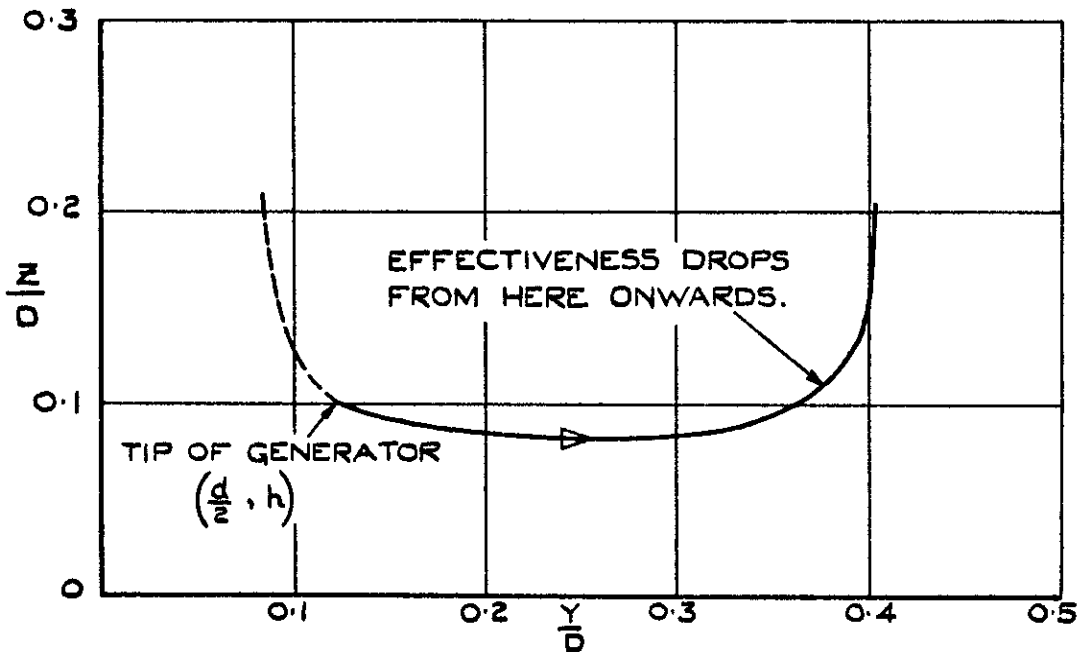
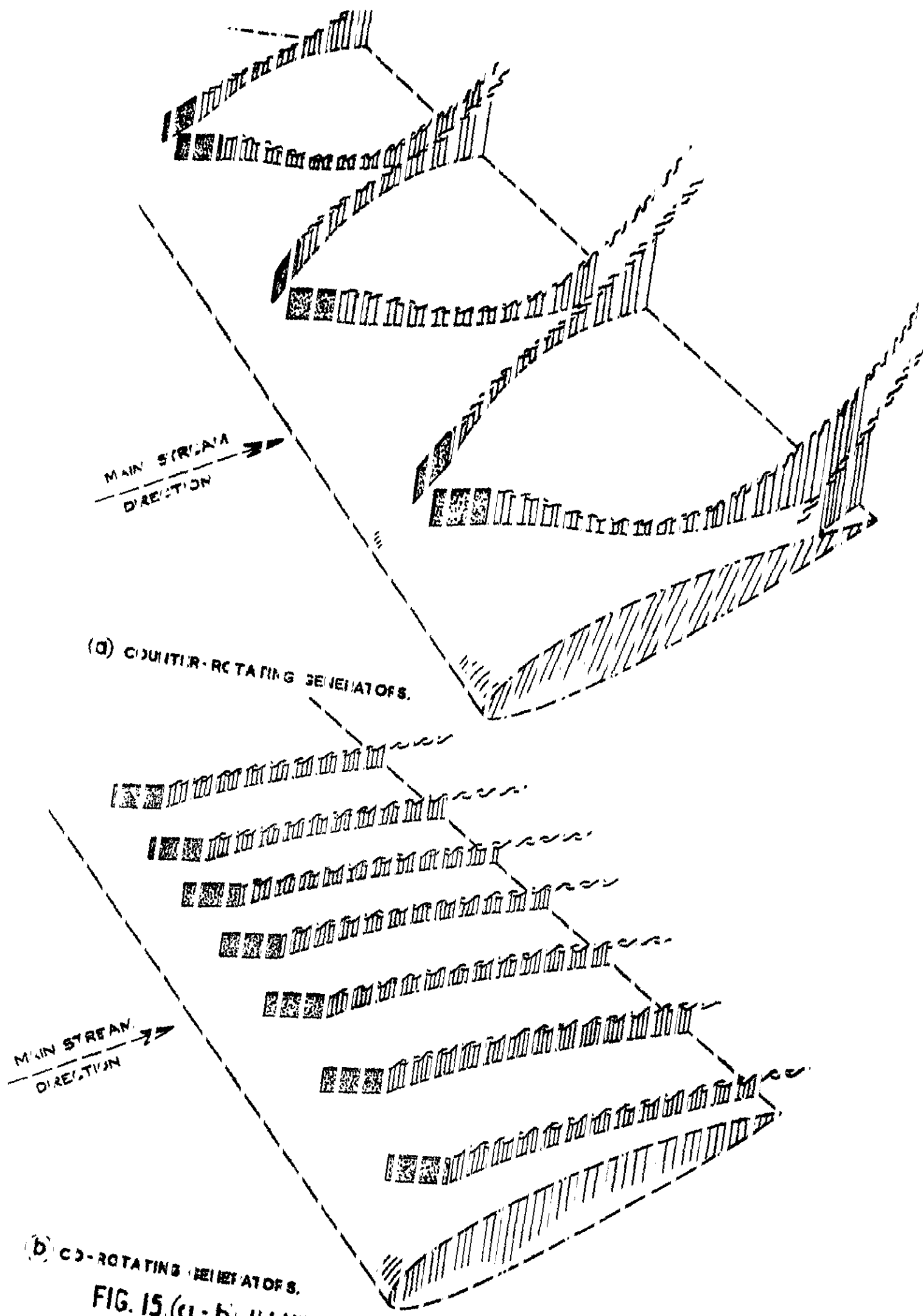

ILLUSTRATION OF NOTATION.



CONFIGURATION 1.

FIG. 14. TYPICAL VORTEX PATH OF A COUNTER-ROTATING SYSTEM IN THE PLANE NORMAL TO THE STREAM



(a) COUNTER-ROTATING GENERATORS.

(b) CO-ROTATING GENERATORS.

FIG. 15. (a - b) ILLUSTRATIONS OF VORTEX PATHS.

A. R. C. C.P. No. 729

FREE-FLIGHT TESTS OF VORTEX GENERATOR CONFIGURATIONS AT
TRANSONIC SPEEDS. Edwards, J.B.W. December, 1962.

533.694.73 :
533.6.011.35 ·
532.526.5
533.694.2
533.6.013.16

Tests have been made to investigate the effectiveness of vortex generators in alleviating the adverse effects of shock-induced boundary-layer separation. The variation in effectiveness of a flap control on an unswept wing in the transonic speed range was taken as a representative example of such effects since it lends itself easily to simple and reliable measurements by the free-flight technique. Most of the configurations were successful in improving the transonic effectiveness, although one made matters worse. Three configurations maintained the improvement through to supersonic speeds where generators were not expected to have a beneficial effect. The results bear out previous findings remarkably well particularly those of small scale tests at N.P.L. This applies to both successful and unsuccessful configurations.

A R. C. C.P. No. 729

FREE-FLIGHT TESTS OF VORTEX GENERATOR CONFIGURATIONS AT
TRANSONIC SPEEDS. Edwards, J.B.W December, 1962

533.694.73 ·
533.6.011.35
532.526.5
533.694.2
533.6.013.16

Tests have been made to investigate the effectiveness of vortex generators in alleviating the adverse effects of shock-induced boundary-layer separation. The variation in effectiveness of a flap control on an unswept wing in the transonic speed range was taken as a representative example of such effects since it lends itself easily to simple and reliable measurements by the free-flight technique. Most of the configurations were successful in improving the transonic effectiveness, although one made matters worse. Three configurations maintained the improvement through to supersonic speeds where generators were not expected to have a beneficial effect. The results bear out previous findings remarkably well particularly those of small scale tests at N.P.L. This applies to both successful and unsuccessful configurations.

A. R. C. C.P. No. 729

FREE-FLIGHT TESTS OF VORTEX GENERATOR CONFIGURATIONS AT
TRANSONIC SPEEDS Edwards, J.B.W December, 1962

533.694.73
533.6.011.35
532.526.5
533.694.2 ·
533.6.013.16

Tests have been made to investigate the effectiveness of vortex generators in alleviating the adverse effects of shock-induced boundary-layer separation. The variation in effectiveness of a flap control on an unswept wing in the transonic speed range was taken as a representative example of such effects since it lends itself easily to simple and reliable measurements by the free-flight technique. Most of the configurations were successful in improving the transonic effectiveness, although one made matters worse. Three configurations maintained the improvement through to supersonic speeds where generators were not expected to have a beneficial effect. The results bear out previous findings remarkably well particularly those of small scale tests at N.P.L. This applies to both successful and unsuccessful configurations.

C.P. No. 729

© *Crown copyright* 1966

Published by

HER MAJESTY'S STATIONERY OFFICE

To be purchased from

49 High Holborn, London, W C 1

423 Oxford Street, London, W 1

13A Castle Street, Edinburgh 2

109 St Mary Street, Cardiff

Brazennose Street, Manchester 2

50 Fairfax Street, Bristol 1

35 Smallbrook, Ringway, Birmingham 5

80 Chichester Street, Belfast 1

or through any bookseller